

SCIENCE FOR THE PROFESSIONS 29:2015

OTEC MATTERS 2015

Edited by Petter Dessne and Lars Golmen



UNIVERSITY OF BORÅS

OTEC MATTERS 2015

Edited by Petter Dessne & Lars Golmen



UNIVERSITY OF BORÅS

THE PRESENT REPORT is the twenty-ninth in the report series *Science for the Professions*. The purpose of the series is to present results from ongoing and finished research projects at the University, as well as publishing contributions in an ongoing discussion about the profiling of science and applied methods within the framework of the idea of Science for the Professions. An annual output of four to six reports is the goal.

Editor of the Series: Björn Brorström, Vice-Chancellor

Assistant Editors: Kim Bolton, Professor, Jenny Johannisson, Deputy Vice-Chancellor

Technical Editor: Jennifer Tydén, Communications Officer

© Petter Dessne & Lars Golmen, 2015

Cover photo: Linus Hammar, Good site for OTEC, Tanzania

Print: Ale Tryckteam AB, 2015

ISBN: 978-91-87525-37-7 (tryckt), 978-91-87525-38-4 (pdf)

ISSN: 1654-6520

In the report series Science for the Professions

1. Forskning vid Högskolan i Borås. Om förhållningssätt, innehåll, profil och metod.
2. Smart Textiles
3. Knalleandan – drivkraft och begränsning. Ett forskningsprogram om företagande, traditioner och förnyelse i Sjuhäradsbygden.
4. In search of a new theory of professions
5. A Delphi study of research needs for Swedish libraries
6. Vad är vetenskap?
7. Styrning i offentlig förvaltning – teori, trender och tillämpningar
8. Profession och vetenskap – idéer och strategier för ett professionslärosäte
9. Framgångsrik förnyelse. Forskningsprogrammet om företagande, traditioner och förnyelse i Sjuhäradsbygden.
10. 20 år med Institutionen Ingenjörshögskolan – historik, nuläge och framtid
11. Fenomenet Ullared – en förstudie
12. Undervisning i en ICA-butik
13. Risker och säkerhet i professionell vardag – tekniska, organisatoriska och etiska perspektiv
14. Knalleandan i gungning?
15. Från Högskolan i Borås till Humboldt, volym 1 – Den svenska högskolans roll i en motsägelsefull tid
16. Från Högskolan i Borås till Humboldt, volym 11 – Bildning och kunskapskulturer
17. Lärarutbildningens betydelse för en inkluderande skola
18. Brukarens roll i välfärdsforskning och utvecklingsarbete
19. Högskolelandskap i förändring. Utmaningar och möjligheter för Högskolan i Borås.
20. Mot en mer hållbar konsumtion – en studie om konsumenters anskaffning och avyttring av kläder.
21. I begynnelsen var ordet – ett vårdvetenskapligt perspektiv på språk och afasi
22. Nätverk, trådar och spindlar – Samverkan för ökad återanvändning och återvinning av kläder och textil
23. Libraries, black metal and corporate finance
24. Veljekset Keskinen – Finlands mest besökta shoppingdestination
25. Kan detaljhandeln bidra till att minska det textila avfallet?: Textilreturen i Ullared – ett experiment om återvinning
26. Från Högskolan i Borås till Humboldt, volym 3
Vetenskap på tvären: akademiska värden, friheter och gränser
27. Samverkan för hållbar stadsutveckling och tvärsektorieell samsyn
28. Ledarskap i vården: Att möta media och undvika personfokuserade drev
29. OTEC Matters 2015

Table of Contents

Foreword _____ 3

Dr. Björn Brorström, vice-chancellor, University of Borås, Sweden

Preface _____ 5

Welcome to OTEC Matters! _____ 9

An introduction to OTEC technology _____ 12

Petter Dessne, founder OTEC Africa, University of Borås, Sweden

Fresh Water from Ocean Thermal Energy _____ 33

Vicente Fachina, Petrobras, Brazil

OTEC in the TROPOS Multipurpose Platform Concept _____ 50

Dr. Lars G. Golmen, Runde environmental centre/Norwegian Institute for Water Research (NIVA), Norway, Dr. Jason C.S. Yu, National Sun Yat-Sen University, Taiwan, & Dr. W. Chen, NIVA, Norway

OTEC advanced composite cold water pipe: An overview of its development and fabrication process validation _____ 60

Dr. Alan K. Miller, Santa Cruz, California, USA

Production of Fresh Water using Renewable Ocean Thermal Energy _____ 69

Dr. C. B. Panchal, Consultant, USA

**OTEC Technology for Aiding Women in Developing Countries:
An Investigation of Women’s Health-Related Quality of Life in
Rural Areas of Iran near the Coast of Gulf of Oman _____ 79**

Zahra Yadali Jamaluei, Department of Sociology and Social Planning, Shiraz University,
Shiraz, Fars, Iran

Preventing environmental impacts of OTEC _____ 91

Dr. Linus Hammar, Chalmers University of Technology, Sweden

**A case study of a hypothetical 100 MW OTEC plant analyzing the
prospects of OTEC technology _____ 98**

Dr. Subhashish Banerjee, India, Formerly of Coventry University, UK, Dr. Les Duckers,
Coventry University, UK, & Dr. Richard Blanchard, Loughborough University, UK

The Lessons of Nature and Heat Pipe OTEC _____ 130

Jim Baird, freelance writer and inventor, Canada

The OTEC Africa Conference 2013 _____ 149

Petter Dessne, founder OTEC Africa, University of Borås, Sweden

Opt for OTEC for a sustainable world! _____ 177

Petter Dessne, founder OTEC Africa, University of Borås, Sweden, Lars Golmen,
Director Runde Environmental Centre, Norway, Ted Johnson, Executive Director, Ocean
Thermal Energy Corporation, USA, Desikan Bharathan, Principal Engineer at National
Renewable Energy Laboratory, USA, & Harold Lever, CEO, Archimedes Solutions, The
Netherlands

Foreword

*Dr. Björn Brorström, vice-chancellor,
University of Borås, Sweden*

In the autumn of 2013, a conference was held at the University of Borås where the technology known as OTEC – Ocean Thermal Energy Conversion – and its possibilities and limitations were discussed. A variety of studies were presented that constituted an overview of the state of the art within OTEC. Some of these studies and presentations, along with other material, have now been gathered together in this anthology which is published in the series “Science for professions” at the University of Borås.

OTEC is a technique for extracting fresh water from salt water while simultaneously extracting renewable energy in the process. OTEC has great potential and very far-reaching positive consequences for application in terms of the supply of fresh water and energy. These possibilities are described in the anthology. The express purpose of the anthology is to introduce OTEC and its benefits and advantages to both laymen and scientists, and to showcase OTEC as a tool for sustainable development in developing countries. It is an advanced technology and it is a fact that facilities and installations for applying the technique require a very substantial financial investment as well as significant efforts and contributions by the various stakeholders involved.

The University of Borås has a strong sustainability profile. Since spring 2012, the University’s environmental management system has been certified according to ISO 14001. This confirmed that the university was strong in this area, and since then our efforts to become a university which meets even more stringent environmental requirements in all significant parts of our activities have been intensified. These efforts aim towards our goal to become a Sustainable University. We improve our rules and practices in order to become more energy efficient and to reduce our negative impact on

the environment, we develop courses and parts of courses where sustainability is in focus in a broad sense, and we initiate and conduct research concerning sustainability. Our initiative to spread awareness of OTEC, highlight the technological development and monitor the development of information and the outcome of its application strengthens and deepens our sustainability profile.

OTEC Matters 2015 is report number 29 in the University's report series "Science for professions". The purpose of the report series is to disseminate knowledge concerning research conducted within the University and to provide a basis for debate concerning scientific ideals and objectives as well as the approach to scientific research. The OTEC Matters anthology describes a technique about which knowledge is vitally important. It is also important to stimulate discussion about the possibilities of the technology and the obstacles that hinder its implementation. The editors of the anthology are Lars Golmen, who is active at the Runde Environmental Centre located in western Norway, and Petter Dessne, who works at the University of Borås. I want to thank them both for an important anthology and a serious commitment to deal with the challenges presented by sustainable development. I would also like to thank the authors for their contributions to the anthology. Finally, I wish everyone interesting reading.

Lars Golmen, Runde Environmental Centre

My fascination for OTEC is rooted back in the 1970's, when there was the first upsurge for renewable energy, following the oil crisis in 1973. Norway has 99 % of its electricity production covered by hydroelectric power. Thinking then about anything else in renewables was something probably most for 'loners', but still, Norway managed to build a significant expertise in ocean energies like wave and tidal energy in the decades to follow, still dwarfed by the emerging offshore oil/gas industry. OTEC remained an exotic technology for us, as the waters off Norway are not suitable for it. By building relations with experts particularly in the US, but also Japan and Europe, I was still able to contribute modestly to some OTEC developments, and to disseminating information in Norway and Europe about OTEC, including through the European Ocean Energy Association, EU-OEA. Over the years I enjoyed meeting and discussing with some of the prominent senior OTEC experts such as Michel Gauthier from France, Prof. Pat Takahashi from USA, Prof. Haruo Uehara, Japan, and the late Don Lennard from UK.

OTEC studies and dissemination will still be a part of the activities at the Runde Environmental Centre (REC), where I work. This new entity on the island of Runde, Western Norway, facilitates scientific research on the natural environment and contributes to the development of innovative and sustainable technologies for fisheries and aquaculture, marine transport and renewable ocean energy. On a regional level, REC is one of three competence centres for renewable energy – with REC's focus being ocean energies, sponsored by the Møre og Romsdal County. At the same time, our energy-friendly buildings and infrastructure serve as both good practice demonstration objects and test cases for implementation of innovative environmental technologies.

When Petter first contacted me about arranging the OTEC conference in Borås, I immediately said yes and agreed to help out forming the program and inviting speakers etc. The present book I think reflects well the scope and results of the conference, and gives an overview of the state-of-the-art of OTEC, although not covering every aspect. Those presenters left out this time will get a new opportunity for including their material in the next volume of *OTEC Matters*.

My end remark is to thank Petter and his staff for the efforts laid down in the OTEC Africa initiative and the conference, and to acknowledge the support from the Møre og Romsdal County that enabled my involvement in the conference and the preparation of this book. Thanks are also due to NIVA, the Norwegian Institute for Water Research, for their support.



Figure 1. The Runde Environmental Centre main building, opened in 2009. REC is organized as a public-private shareholder company. See more information on <http://www.rundecentre.no>.

Petter Dessne, OTEC Africa

Every story has a beginning. And I believe that for us who are dealing with oceanography research, or just have an interest in oceans in general, there is also a story to tell. A story that might have started with a fascination for – and perhaps even an admiration for – the ocean. For me, the story began when I was just two years old.

My grandmother used to tell me how I wandered off as this two-year-old little boy from her summer house, an old cottage in the fishing village

Gåsholma by the Baltic Sea. She always found me close to the shore, looking out over the sea. When asked what I was doing, I simply answered: “Look sea.” I could sit there for hours, apparently spellbound by the rolling waves constantly hammering the rocky beach.

Of course, I have no recollection of this, but I always have had a love for the ocean. This love led me to oceanography studies in the early years of this century, and later to the founding of OTEC Africa, of putting together the OTEC Africa 2013 conference (together with Runde Environmental Centre and the University of Borås), and to the production of this book, the first volume of *OTEC Matters*.

I am writing my part of the preface just days after the UN presented its new report on climate change, and it comes as no surprise that even more alarming news relating to climate change are revealed. When releasing this report, the UN Secretary General said that the United Nations “is bringing the world together on energy, because energy is central to our future well-being as a human family”¹. He also addressed sustainable development of low-income countries, and reported from a recent journey to the Horn of Africa:

I have come here from the Horn of Africa. There, millions of people are affected by conflict, poverty and environmental threats, including the impacts of climate change. I have seen for myself these deadly effects affecting many people in the Horn of Africa, particularly in Dadaab refugee camp.

They are making progress – but we need to support them.
[...] Energy will be an important part of that effort – and so will climate action.

Stopping climate change, exploring technologies for clean energy, and developing low-income countries is exactly what this publication is about. Of course, the publication centers on OTEC, but one must recall that OTEC is far more than “just another renewable technology” – it is a means towards making these things happen.

¹ The speech is available at <http://www.un.org/sg/statements/index.asp?nid=8152>.

I would like to conclude my part of the foreword by saying thanks. My gratitude goes to Mikael Löfström, the dean of the late School of Business and IT, both for the financial support of this project and for his friendliness and honest interest, to the vice-chancellor of the University of Borås and publication series editor Björn Brorström for his genuine interest in my projects and for his ambition to support science that aims to create a sustainable world, to my dear friend, conference co-organizer, and now *OTEC Matters* scientific editor Lars Golmen, and to the kind people in the OTEC community – industry people and scientists alike.

On a personal note, I'd like to thank my brother Olle and my parents Malin and Lars, all fine scientists in chemistry, medicine, and biology and improving lives for thousands if not millions of people in industrialized and developing countries, for much appreciated help and inspiration on the road to environmental sciences. But most of all, I'd like to thank my wife, best friend, and sustainability co-worker Karin and our pride of korat cats for their never-ending love.



Figure 2. Swan family at the rocky shore of the fishing village Gåsholma in Eastern Sweden. Photo by Astrid Wagner. Used with kind permission.

Welcome to OTEC Matters!

It is with great excitement that this this very first volume of *OTEC Matters* is being published. The editors hope the publication will run for many years and cover the many facets of OTEC and related matters, such as OTEC technology, sustainability including gender and other social studies, renewable energy, marine biology, metallurgy, and developing countries.

With several commercial breakthroughs this year, the first volume of this publication seems to be just right in time.

Our intention with this publication

The publication is aimed at two different audiences, and we hope that both will have use of at least some texts. One of the two groups of people we hope to reach is scientists directly or indirectly involved with OTEC technology, and we are certain that this group will appreciate several of the more “hard-core” texts on advancements in this field. The other group this publication tries to reach is more diverse, consisting of scientists from non-technical fields, industry people, politicians, investors, educators, and more. Also for this group there should be plenty of interesting texts to read.

Our – somewhat unorthodox – advice to the readers of the publication is: Skip the parts that at first glance look irrelevant to you! Most readers will probably be more interested in one kind of articles than the other (i.e., the ones with equations in them or the ones without). By the time you have read through the texts that immediately caught your eye, and thus dug more into the subject, the other texts may look more appealing than they did before.

A note on the variations of the texts

Our intention is to keep a high standard for included material, but at the same time give room for various views and also different kinds of texts, and so, the texts differ in style, length, and overall approach.

In this publication, all major temperature scales – Celsius (C), Fahrenheit (F), and Kelvin (K) – are used. Celsius and Kelvin are the same; the only difference is that Kelvin starts at absolute zero and Celsius at the freezing/melting point of water (273.15 K). A Fahrenheit degree is a little more than half of a Celsius degree.

In this volume

This particular volume features many aspects of OTEC, but has two main tracks:

1. Introducing OTEC and its benefits to laymen and scientists, and
2. Presenting OTEC as a tool for ensuring a sustainable development in developing countries.

The volume starts out with an introduction by the editor to what OTEC is, how this technology can benefit both industrialized and developing countries, and what difficulties there are today and how these may be overcome. This introduction, aimed at an audience not necessarily familiar with physics, is followed by a paper by Vicente Facina at Petrobras, investigating how Brazil would benefit from big OTEC plants.

Next follows a report by scientists Lars Golmen, Jason Yu, and W. Chen on the unique TROPOS project, the development of a floating modular multi-use platform system for use in deep waters. The primary locations for the TROPOS project are Crete, Gran Canaria, and Taiwan.

An issue of financial interest for OTEC technology is the cost of material for the long and wide pipes for getting cold deep sea water. In the next paper, Alan Miller, previously at the American industry giant Lockheed-Martin, discusses the pros and cons of several types of materials for these pipes. He also describes the testing process carried out for them.

Also from the United States, C. B. Panchal joins the discussion of using OTEC for fresh water production, focusing on the tremendous opportunities for the fresh water needs of Africa and Small Island Developing States (SIDS).

Dr. Panchal's text is logically related to and followed by a paper on how fresh water from OTEC could help obtaining equal rights for women in Iran. The absence of potable water is always a hinder for obtaining equal

opportunities between genders. This aspect is important to highlight; when deciding between OTEC and other energy sources, it's all too easy to just perform calculations on earnings and costs related to electrical power.

All technologies have a potential negative impact on the environment. In OTEC's case this is related to the large quantities of water being moved from the surface to the deep and vice versa. Linus Hammar expands on some conclusions from his doctoral thesis on OTEC for low-income countries and notes that even if large scale OTEC should prove to cause problems in coastal regions, OTEC's strengths in terms of electricity and fresh water still makes the technology immensely valuable in the right locations.

So just how attractive are large OTEC plants, in terms of producing electrical power, fresh water, and other beneficial products? This question is answered by Subhashish Banerjee, Les Duckers, and Richard Blanchard in their case study of a hypothetical 100 MW OTEC plant. The biggest plants today are much smaller, but reasoning about really big plants is not too early, as investigations as the one published here will point towards the future of OTEC, and be instrumental when designing these larger plants.

Indeed, *OTEC Matters* is not only about reporting on past experiments but also about looking forward. Therefore, this volume continues with a paper by freelance writer Jim Baird proposing the use of heat pipe engines for making OTEC even more efficient and also further improve on its value for the environment.

As this volume focuses on OTEC for developing countries, it contains a report from the OTEC Africa Conference 2013, the first international conference solely dedicated to OTEC. The object of the report is to present the many facets of the technology and its uses, and also to introduce many old and new actors in the field. The text tries to reflect the positive spirit of the conference and of the OTEC community as a whole.

At the very last, a translation of an opinion piece promoting OTEC is republished. It was originally published in the prestigious Swedish newspaper *Svenska Dagbladet* this year, and focuses on OTEC for sustainability and for creating opportunities for the Scandinavian industry.

An introduction to OTEC technology

*Petter Dessne, founder OTEC Africa,
University of Borås, Sweden*

OTEC in brief

Life began at sea. Therefore, it's appropriate that many of the future energy resources, which will help development all over the world and help mankind's fight against global warming, also originate on or far beneath the surface of the sea.

Ocean Thermal Energy Conversion technology, or OTEC in short, is a hundred-year-old but little known clean technology for extracting energy from sea water. In addition to producing electricity, some of the sea water running through an OTEC plant becomes desalinated, and can produce thousands of cubic meters of fresh water every day. OTEC can also be used for cooling buildings, for providing the fishery industry with nutrient-rich water, and for several other purposes. In short, it's a technology with many benefits, and its versatility makes OTEC unique.

The heart of OTEC is the use of the temperature difference between warm surface water and cold deep sea water. This might not seem like a great source of energy, but in fact, water is able to hold large amounts of energy (which is why it takes so long to heat water on a stove): With a temperature difference of 20 °C between a cubic meter of surface water and a cubic meter of deep sea water, the difference in energy is roughly 20 million calories or about 80 MJ, and releasing this energy in one second would produce about 80 MW of power (there are 4.18 J per calorie). As Garrison points out, extracting this heat energy from about 1,600 cubic meters of water per second would equal the power of all US nuclear power plants (Garrison 2007, p. 482)! OTEC provides a way of harvesting a small part of this difference in heat energy and convert it to electrical power. Considering the amount of solar radiation that the oceans receive on a daily

basis, trapping some of this energy does feel promising. In fact, OTEC can be viewed as a technology feeding on solar energy, temporarily stored in the top layers of the oceans.

OTEC only works efficiently where the difference between the ocean surface and the deep water is at least 20 °C, and for this reason countries near the equator can benefit the most from the use of OTEC. As the plants can be built on land, as platforms close to shore, and as mobile solutions on large vessels, there are still vast areas that can be used for this technology, about 60 million square kilometers (Avery 1985). Industrialized countries/regions having OTEC resources include – but are not limited to – Japan, Southern USA, Brazil and India. Because of its ability to produce both electricity and fresh water, OTEC would be of even more value to several developing countries in Africa, such as Tanzania, Mozambique, Kenya, and the Western Africa region, as well as other developing nations close to the equator such as the Philippines and several Arabic/Persian nations. As many as about a hundred nations and major islands can have direct use of OTEC (Vega 2010). The image below shows where the temperature difference is the highest, thus providing the most efficient locations for OTEC facilities¹.

There are ideas that can expand the territories in which OTEC can be used even more, or increasing the net effect of the technology. One such idea is using so-called solar ponds, large floating basins used for heating the surface sea water with the radiation of the sun. The OTEC process can then feed on this heated water, thus having a much larger temperature difference than in ordinary cases. Using solar ponds may have environmental concerns however, and the idea must be investigated properly.

Heated water is actually also present far away from the equator, for example, as a result of the discharge water of nuclear plants. Dr. Lars Golmen has recently proposed “bottom-cycle OTEC” for this particular application. In an opinion piece, he states that water heated at an onshore gas terminal with about 300 MW of waste heat (cooling water) can be used in an OTEC process exchanging with Norwegian fjord water (Golmen

¹ As far as OTEC Africa is concerned, the important region is also marked in the project's logotype (actually some of the best sites for OTEC are situated a bit south of the striped area, such as outside Tanzania and Mozambique).

2014). OTEC as an underlying idea also can have other purposes. In September 2014, the Californian company Calnetix issued a press release stating that they have managed to use the heated jacket (waste) water of marine engines to produce up to 125 kW of net electrical power (Calnetix 2014).

Though a fascinating technology, OTEC, after some intensive investigations around 30 years ago, was disregarded by leading institutions as being too expensive for serious investigation, research, and above all, investments. The high oil price, new advancements in OTEC technology, and an increased awareness of the need for sustainable energy have turned things around, and the time has finally come when OTEC plants are being built on a slightly larger scale.

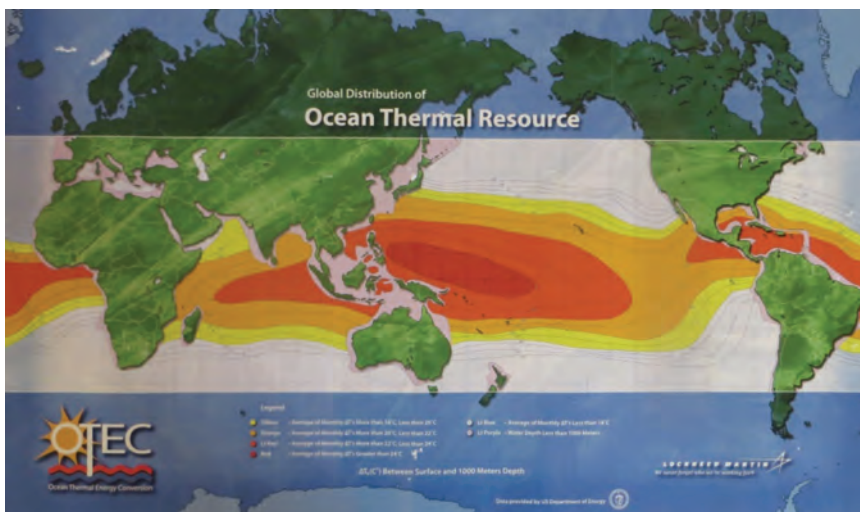

Figure 1. The global distribution of the ocean thermal resource. The darker color, the warmer the surface water. Some regions (such as close to the north Australian coastline) are not marked although they are warm. This is because conventional OTEC does not seem feasible as the ocean depth is too small or the deep ocean water not cold enough. Image from Lockheed-Martin, photographed by Dr. Alan Miller. Used with kind permission.

Indeed, the recent few years have seen a rapidly increasing interest in OTEC:

- ♦ In June this year, the French companies Akuo Energy and DCNS were funded to constructing and installing a number of OTEC plants adding up to 16 MW outside the coastline of the Martinique island. This is by far the biggest OTEC platform ever built, and the EU has allocated 72 million euros for this purpose (DCNS Group 2014).
- ♦ At the same time, the American company OTE Corp. has started working with several industrialized and developing countries for investigating suitable OTEC sites, infrastructural solutions, and funding opportunities. (Ocean Thermal Energy Corporation 2014a)
- ♦ In addition, the American industry giant Lockheed Martin has recently designed an award-winning 10 MW OTEC plant, together with the industry group China-based Reignwood Group. According to the company, just “one 10-megawatt OTEC plant could provide reliable, clean energy for approximately 10,000 people; replace the burning of 50,000 barrels of oil; and eliminate the release of 80,000 tons of carbon dioxide per year into the atmosphere.” (Lockheed Martin 2014)
- ♦ The last couple of years have witnessed the advent of two NGO’s promoting OTEC: OTEC Foundation (based in The Netherlands) and OTEC Africa (based in Sweden).
- ♦ Last year, the world’s first international conference dedicated to OTEC (www.otecafrika.org/conference), was held in Borås, Sweden, and what you are reading now is the first volume of what we hope to become an annual or semi-annual publication devoted to OTEC technology and related matters. (A conference report is published as part of this publication.)

Judging from my own experiences from the OTEC Africa Conference and from various communications with respective parties, and from press releases on partnerships and memoranda of understanding (eg. Ocean Thermal Energy Corporation 2014c), it seems clear that the industrial, the academic, and the governmental sectors from all over the world are now coming together to make century-old ideas come true.

How OTEC works

As said above, OTEC is a clean technology for extracting energy from sea water, and the process resembles geothermal heating. In addition to producing electricity, some of the sea water running through an OTEC plant (the working fluid in an Open Cycle plant) becomes desalinated, and can produce thousands of cubic meters of fresh water every day.

The OTEC process can be described as follows: Platforms are placed near a coastline with warm surface water (preferably 25 °C or more as the process needs a 20 °C temperature difference in order to work and the more the better), where cold deep-sea water is pumped to the surface using very large pipes, about a thousand meter long and several meters in diameter. It is then possible to transform the difference in heat energy to electricity through the use of heat exchangers, compressors, turbines, and generators. Depending on the method used, surface water may become evaporated and in that way turned into potable water of high quality.

The needed temperature difference can be found in large areas of the tropics that account for about a third of all ocean water. Still, OTEC has a low thermodynamic efficiency; typically, less than 3 % of the energy extracted from the surface water in OTEC goes into electricity. This is about a tenth or fifteenth of the efficiency of an automobile engine, but on the other hand sea water is free, and petrol is not only expensive but also hazardous to the environment. Using the sea water flow in other processes as well (for aquaculture etc.) makes OTEC not only more usable but also more economically feasible.

OTEC plants may be installed on-shore, but can also be constructed as floating platforms, similar to oil platforms. Platforms in the sea means shorter distance to the deep cold water, but requires a power cable to bring the electricity to shore, unless the electricity is used altogether on the floating platform (for example, for producing hydrogen compounds for the automotive industry). OTEC systems can also be placed on ships, which can then travel the oceans and run the OTEC process where the surface water is, for the moment, at its warmest. The power generated can be temporarily stored on ship, and if using big tankers for this process, potable water can be

stored on board as well, to be added to a nation's water supply at a later point in time.

The two main methods (it's also theoretically possible to combine them into a hybrid type) are closed-cycle OTEC (abbreviated CC-OTEC) and open-cycle OTEC (abbreviated OC-OTEC). The underlying principles for those technologies are briefly described below.

Closed Cycle OTEC

Warm surface water and cold deep sea water are used to vaporize and condense a working fluid, such as ammonia, which drives a turbine and then a generator in a closed loop, producing electricity. This method generates more electricity than the open cycle method does, but it doesn't generate fresh water.

Open Cycle OTEC

A chamber is filled with water from the surface. A pump creates a vacuum, thus lowering the atmospheric pressure until the water starts to boil. (Pressure regulates the temperature at which a liquid boils; a comparison can be made with a pressure cooker for fast cooking at home, where high pressure makes the water hotter than 100 °C without starting to boil.) The resulting steam from the surface water – about 0.5 % of this water flow is sent into the chamber – is used to drive a turbine, which in turn drives a generator. Cold deep sea water is used to condense the steam to fresh water after it has passed through the turbine.

In OC-OTEC there is, as the name says, no closed loop. Instead, “new” water is retrieved from the surface. The previously vaporized and then condensed water is now desalinated, thus turned into fresh water.

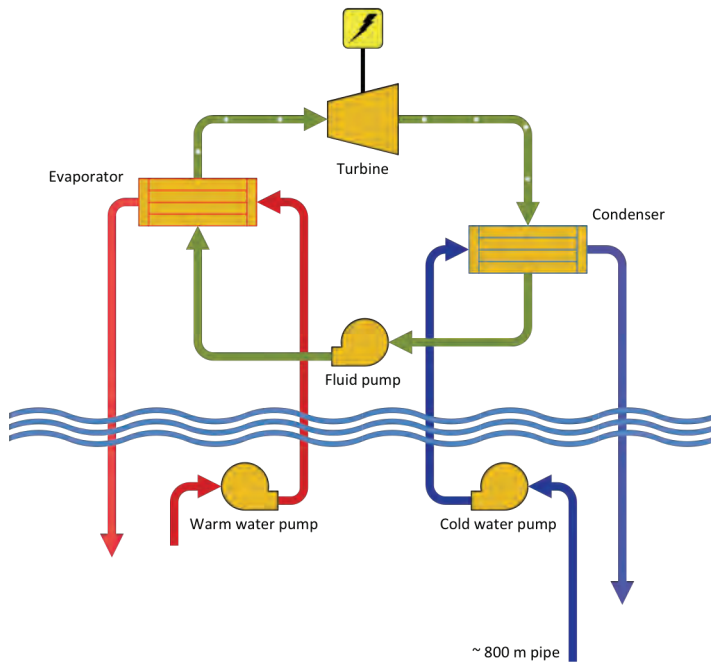

Figure 2. The working principle for closed cycle OTEC. A working fluid such as ammonia vaporizes in an evaporator. The gas is led through a turbine, which drives a generator and in turn generates electrical power. A condenser is used to return the fluid to its original state, and using a pump, the process is repeated. Surface sea water is used to heat the fluid in the evaporator, and deep sea water cools it down to liquid state in the condenser. During the process, the surface sea water returned to sea becomes a few °C cooler, and the deep sea water a few °C warmer than previously. Note that the deep sea water, the surface water, and the working fluid never mix; the deep sea water is typically discharged at minimum 60 m depth not to alter the local environment of the surface water layer. Figure by the author.

Note that a complete understanding of the two OTEC methods is not essential in order to appreciate the merits of the technology, the OTEC Africa initiative, or the intentions of the writers in this publication.² After all, the technology has been proven to work and the earlier problems that

² A highly illustrating picture of how OTEC works can be seen at a web site whose object is to make Norwegian students interested in the energy sector. The Flash graphics are available at <http://ungenergi.no/fornybar-energi/energifrahavet/otec/> (though legend in Norwegian and not visible in all web browsers).

OTEC have faced have been related to the cost-effectiveness of OTEC technology versus the price of crude oil.

OTEC benefits

In an excellent introduction to OTEC as well as an often cited article, Dr. Luis Vega discusses the various benefits of OTEC (Vega 2002/2003). Of most importance is electrical power and the production of fresh water, but there are also byproducts such as sea water air conditioning (SWAC), the possibility to bring nutrient water to enhance mariculture productivity, hydrogen production, and the acquiring of trace metals. In his keynote speech at the OTEC Africa Conference 2013, Dr. Ted Johnson showed that just one 100 MW floating OTEC plant:

- provides base-load electricity for 100,000 people by producing 800 Million kWh per year
- replaces 1.3 million barrels of oil each year, and in so doing, avoids the generation of up to 800,000 tons of CO₂ per year
- produces 120 million liters of fresh water per day
- moves four km³ of high nutrient deep sea water each year, enough to grow 70 tons of shellfish meat each day. (Johnson 2013)

Over the years, there have been several calculations performed on the prospects of electrical power generated from OTEC (and some more calculations are added in this publication). Of concern here is the price of crude oil, as that is still the least expensive energy resource traded worldwide. In this text, it is assumed that the price of OTEC energy is higher than the least expensive alternative. Note though that the larger the plant, the lower the cost per kWh. Speaking for OTEC is the fact that, in addition to the technology being absolutely clean and versatile beyond competition, OTEC is extremely reliable, producing uninterrupted electrical power and fresh water regardless of weather conditions and seasons.

As said above, OTEC is the only technology that produces both electricity and potable water. The quantities of potable water achieved in the OC-OTEC are substantial. The numbers vary lightly on just how much potable water can be produced by OTEC, but one figure is 800,000 gallons (3,000 m³) per MW (Ocean Thermal Energy Corporation 2014b),

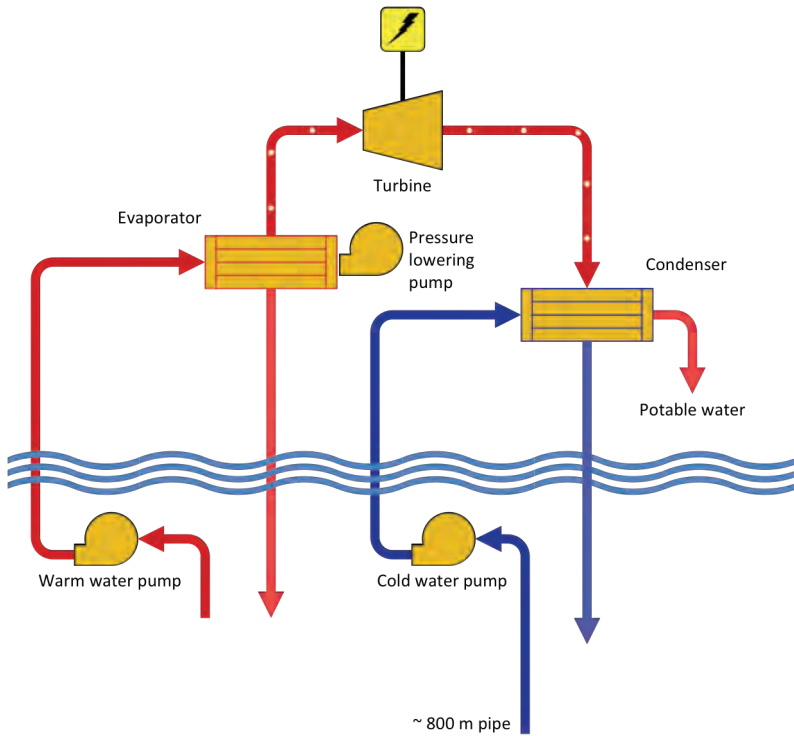

Figure 3. The working principle for open cycle OTEC. Using a powerful vacuum pump, the pressure in the evaporator is lowered to about 1 % of the atmospheric pressure. This causes a small amount (circa 0.5 %) of the surface sea water flow to boil, and the rest is returned to sea as used cooling water. The (desalinated) vapor goes through the turbine, as in the CC-OTEC process, and electrical power is retrieved. When condensed using the colder deep sea water, potable water is obtained as the vapor returns to liquid state. Note that the deep sea water and the surface sea water never mix during the process, as they are fetched from and released at different depths. Figure by the author.

indicating that a single OTEC plant can support an entire city with fresh water. For many developing countries and small island developing states (SIDS), reliable fresh water production is currently the main reason for investing in OTEC.

Several researchers have also pushed for OTEC as a technology for boosting mariculture projects. This is because deep sea water is more nutrient-rich than surface sea water, and transporting some of the discharge

deep sea water to mariculture production sites will give a radically improved harvest of clams and similar organisms, something that can help in the fight against world hunger and provide many low-income countries with exporting opportunities. In the future, the importance of mariculture may increase as the world's population will need new ways to acquire food, and so, using OTEC for mariculture may prove to be a strong argument for the technology.

The cold deep ocean water can also be led through pipes to establish sea water air conditioning (SWAC). SWAC is a cost-effective and environmentally friendly way of cooling buildings, but relies on deep sea water being pumped into the cooling system. Especially in the countries where OTEC works best, the need to cool facilities such as hospitals and food production buildings is the biggest. SWAC is used today all over the world (even in Stockholm) but doing SWAC as a simple byproduct of the discharging of deep sea water should be a compelling argument to the OTEC advocates.

It is not a trivial task to convert heat energy to electrical power in the middle of the ocean and then transport this power to an onshore electrical grid. There is also rather expensive hardware involved. In addition, using an undersea cable, powerful batteries, or other solutions for transporting the power results in energy losses along the way to the consumer. For offshore OTEC, an often more appetizing approach is to use the energy on the OTEC platform for other purposes, such as for the production of different liquids or gases, which in turn can be used for the automotive industry or other tasks. Currently, hydrogen gas production is probably of most interest (challenged by ammonia):

The technical evaluation of non-electrical carriers leads to the consideration of hydrogen produced using electricity and desalinated water generated with OTEC technology. The product would be transported, from the OTEC plantship located at distances of about 1,500 km (selected to represent the nominal distance from the tropical oceans to major industrialized centers throughout the world) to the port facility in liquid form to be primarily used as a transportation

fuel. A 100 MW-net plantship can be configured to yield (by electrolysis) 1300 kg per hour of liquid hydrogen. (Vega 2002/2003)

Hydrogen gas can be created via electrolysis of the sea water, where electricity from the OTEC platform runs the following simple transformation:

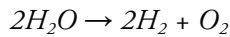

For the time being, using OTEC for hydrogen gas production is not economically justifiable. However, prices vary greatly when it comes to natural resources, and so, the production of liquids and gases should definitely not be overlooked. Instead, OTEC plants should be configured with the possibility of supporting this kind of production in the future.³ In fact, hydrogen gas production can be very promising, especially if future communities abandon fossil fuel altogether. If so, hydrogen gas from OTEC plants can be financially viable, according to calculations made in 2005 (Van Ryzin, Grandelli, Lipp & Argall 2005). During the OTEC Africa Conference 2013, Dr. Martin Brown proposed using OTEC technology for floating liquefied natural gas (FLNG) plants, used for making transport of natural gas easier and less bulky (see the conference report in this publication).

The world's oceans contain impressive masses of trace elements, such as gold, magnesium, and molybdenum. For instance, there is approximately MUSD 15 worth of gold per km³ of ocean water (Garrison 2007, p. 199). During the OTEC process, these trace elements can, in principle, be harvested. Today, this would be extremely uneconomical, but the needs of future societies and technologies will differ from ours, and at that time, extracting trace elements can be of value after all.

³ Overall, the cost of OTEC will come down once the production of the plants can be serialized. As this means other features than electrical power and fresh water can suddenly become more appealing, the plants should be designed to be as flexible as the technology itself.

OTEC has also been proposed to power underwater mining operations (United Nations 1979, p. 121), but for the time being this idea is not pursued.

A consequence of the OTEC process is that the temperature at the sea surface is slightly lowered. When tropical storms form, the severity of the storms is directly related to the temperature levels of the surface. With a decrease of the temperature at the birthplace of the storms, the impact of a storm is quite much lowered. The warmest waters of the Earth are rather close to the Philippines, and setting up a large number of OTEC plants in that area could in theory lower the damage of future typhoons. To what extent this could be achieved is not yet fully understood, and in any case, this undoubtedly benevolent effect lies a few decades ahead because of the need of large-scale OTEC plants. Needless to say, considering the tragedies and enormous economic losses caused by hurricanes/typhoons/cyclones, any possible option for hindering these increasingly powerful events is at least worth looking into.

Regardless of how an OTEC plant is configured, it does run massive quantities of water through its system. This could have some positive effects. For example, there exists an environmental problem of gigantic proportions with tons of plastic debris in each of the five ocean gyres (for example, the Sargasso Sea), which impacts many organisms living in the sea. Even if some of these gyres are not in perfect OTEC locations, using large solar ponds the surface water can be heated and make the process work. This way, debris sucked into the ponds could perhaps be filtered out before the water is used in the OTEC process.

The movement of water can be used for many purposes. For example, due to overuse of fertilizers in the USA, the waters outside the Mississippi delta are today lacking in oxygen, killing off a large part of the ocean life. At the same time, as explained above OTEC can be used for making hydrogen gas, leaving oxygen as a byproduct. Theoretically, this gas could be pumped back in the ocean as long as there is a need for it to restore the ocean life of the area.

Similarly, some parts of the oceans are consistently becoming saltier as the sea water evaporation increases due to global warming, and these places coincide with the ocean gyres (National Oceanic and Atmospheric

Administration 2008). OTEC has been proposed as a means to desalinating these so-called “ocean deserts”. Again, this is something that calls for OTEC plants built on a large scale, and if ever an option, it will be many decades away.

Not only O₂ but also liquid CO₂ could be pumped into the ocean. In truth, the oceans are candidate places for putting this gas away. The oceans already contain an equivalent of 140,000 gigatons of CO₂ and many times this amount can be sequestered before the sea water becomes saturated. The world’s known oil resources will produce much less than this, so as long as the CO₂ can be trapped, OTEC can be used for sequestering of it there. Researchers Lars Golmen and Stephen Masutani have found that a 10 MW OTEC plant have adequate water flows to handle the emissions from a 1 GW combustion power plant (Golmen & Masutani 2000).

It should also be mentioned that the major obstacles of sea-based wind power and wave power is harvesting the electrical power these technologies produce. Equipping OTEC plants with wind and perhaps also wave power structures would therefore be very beneficial, as an OTEC plant will already have some kind of system for using the electricity produced. It is therefore of importance that connections between the OTEC community and these mentioned communities are formed: these particular technologies complement each other and should not be viewed as rivalling.

Although fresh water production from reverse osmosis (RO) *is* a rivalling technology, OTEC plants could be used to deliver the energy needed to run the RO facilities. The same goes for several other more or less clean technologies.

The deep ocean water can also, instead of being pumped back to the lower sea layers, be pumped to deserts such as Sahara. There, this water can be used to water plants (halophytes) that “feed on” the salt water (Debez, Huchzermeyer, Abdelly & Koyro 2011), and in turn create basins of fresh water, fighting off desertification (see for example www.desertcorp.com for further details).

In short, some of OTEC’s benefits are available already, and explain why OTEC plants are now being built. Others are yet on the idea stage, and those plans might never go beyond propositions. In any case, the more experimental of the features mentioned above are in need of OTEC plants

on a scale that simply isn't available yet. Subsequently, there will be years – probably decades – of OTEC technology advancements before these ideas will ever be considered, at which point a lot of environmental research data should be available. This iterative development minimizes the risks that OTEC technology will be used in ways that may have unintentional consequences for the local or global climate.

In an over-populated world becoming more densely populated each day, political instability follows and will follow with the absence of electrical power and access to fresh water. In addition to killing several millions of people each year, the absence of fresh water also hinders women liberation. Providing communities with fresh water and electricity, OTEC can be used as a tool towards generating stable, democratic, and gender-equal societies.

For a long time, OTEC has been considered (or not considered) for its ability to produce electricity. At the moment, among many researchers the main strength of OTEC seems to be its ability to produce potable water. In two decades, boosting the mariculture sector may be viewed as even more important (eg. Golmen, Masutani & Ouchi 2005). Hydrogen gas and liquid natural gas production may also well be the most important aspects of OTEC a decade or two from now. Thus, the only thing we know today is that we *don't* know what feature of OTEC we will appreciate the most in the future. Being a technology blessed with many talents, OTEC should be well worth exploring further, as it can be designed and altered according to our needs.

Concerns

It should by now be clear that OTEC has several and exciting possibilities, and having all this flexibility and usefulness in one product is rare. That said, there are – as with all energy-related technologies – concerns involved with OTEC, and they are discussed in the following.

Cost of OTEC plants

OTEC is not a cheap technology, as the plants need to be big in order to generate enough energy from the water temperature differences. Dr. Luis Vega has illustrated how the cost per kWh becomes smaller the bigger the

OTEC plant is (Vega 2010), which is another way of saying that when it comes to closed cycle OTEC especially, building small OTEC plants make little sense except as demonstrators, and building big plants takes some serious investing.

While sketches of plants of 50 or even 100 MW look impressive, they may be too expensive for many low-income countries (that said, companies such as OTE Corp. offer financial solutions for this long-term kind of investment). Hopefully, when the production of OTEC plants become more streamlined, it will make more economical sense to produce also small-size plants. A strategy to consider would be to investigate the possibility of producing a series of smaller semi-automatic OTEC plants, which may not look at all like the ones known today and that can easily have their parts repaired or replaced if they stop working. These smaller plants could then provide local communities along the coastlines of many developing (and industrialized) countries with electricity and fresh water.

At least in the current market, the cost of electrical power from OTEC plants – big or small – is undoubtedly higher than the price of crude oil, but the combination of electricity and fresh water makes OTEC financially sound in many regions. For the time being, of the two methods, it thus seems as OC-OTEC has the upper hand.

Displacement of water

Something that has been brought up from time to time over the years is the ecological consequence of moving large quantities of deep sea water to the ocean surface; even if it's nothing wrong with the water itself, it has slightly different temperature and chemical proportions. If used carelessly, this could lead to problems with certain fishes and with nearby coral reefs, for example, as even small OTEC plants displace between 50 and 100 m³ per second of nutrient-rich water (Hammar 2011, p. 46). Of course, when deciding on suitable OTEC sites, this is taken into account. Possible consequences to the ecosystems is hindered to a large degree by letting out the deep sea water many meters – a hundred or so, depending on the structure of the water layers at the site in question – below the surface.

Entrainment of fish and sea-living mammals

Another cause for concern is the entrainment of animals living in the oceans. The pipes used in OTEC are quite wide – up to 10 m in diameter, and therefore, there is a risk that animals are sucked into the OTEC system. Researchers at universities and at consultancy companies such as Alden Labs are working on solutions for preventing this from happening and are doing research on this matter for both OTEC systems and other applications.

Other risk factors

Delivering only electricity and fresh water, fuelled by seawater, OTEC can be said to be a low-risk technology. In addition to the risks and concerns mentioned above, other risks are more obvious, and relate to possible leakage of ammonia⁴ or similar working fluids, and to risks of working with constructions at sea. No energy-related technology is entirely risk-free, but OTEC and a few other clean technologies relating to transforming the energy coming from the sun must be considered very appealing as far as production versus risks are weighted against each other.

Why now?

OTEC is not a commercially much used technology presently, even though the OTEC principle has been known well over a hundred years. One reason for this is the fact that the oil price historically has been too low in order to make OTEC profitable (and accordingly, there was a peak in OTEC research in the mid-seventies, due to the severe oil crisis). As a consequence, there has before the twentieth century been little interest in this and many other environment-friendly energy sources.

This situation has changed dramatically in the past few years, thanks to an oil price that continues to rise, and to an increased awareness of how emissions from fossil based fuel affect our entire planet. As mankind painfully gets to grasp with the downside of a fossil based way of living,

⁴ However, the environmental risks of using ammonia should not be overstated: A leakage of relatively small amounts of ammonia is not severe – the ammonia becomes ammonia ions that are swiftly absorbed by the biological system.

researchers, entrepreneurs, and governmental institutions seek for alternative resources of energy, and so, the technology is starting to take off.

It's not, however, only producers and governments that turn their focus to clean energy resources, but also end consumers, who want more environmentally friendly ways of driving their cars, heating or cooling their houses, or charging their cell phones (all being suitable usages of OTEC products).

One reason why it has taken so long to commercialize OTEC is that OTEC is a little known technology and the OTEC community is rather small. This is something that soon should be rectified with the recent successes on the sales front, and also through increased coverage in media, contacts with politicians, and other information activities.

Today, scientists and industry people from the USA, France, Great Britain, The Netherlands, South Korea, Brazil, Nigeria, Japan, and more countries are all doing OTEC research, and it is just a matter of time before



Figure 4. The Earth at night. A collage of images taken by NASA in 2012. One can imagine the energy consumption when African and South American nations shine as bright as populated areas of Europe and North America. The presenting NASA scientist notes that “easy to recognize here, city lights identify major population centers, tracking the effects of human activity and influence across the globe. That makes nighttime images of our fair planet among the most interesting and important views from space.” (NASA 2012) Used with permission.

more and even bigger commercial plants are being built. Many OTEC researchers are already discussing plants of 50 MW or 100 MW, and even if the realization of such plans is perhaps a decade away, ten years is not a long time in energy and infrastructure discussions.

Many developing countries are now rapidly becoming more and more industrialized. This positive advancement has a backside: the world's energy resources will be more and more strained. At the same time – who are we in the industrialized parts of the world to deny other people the same material standard as we have today? The solution for the world's increasing demand for clean energy and disease-free potable water must exist within new energy resources, there is simply no other way.

The image showing the night lights of the Earth tells a story about who is rich and who is poor in the world. But more than this, the image tells of a future with a heavily increased need for clean energy, which in turn needs more investments in research and funding of energy-related technologies such as OTEC.

For each city lightening up in developing countries, more and more strain will be put on the world's energy resources. At the time developing countries are as well lit up as industrialized, we must have made significant progress in the renewable energy area. OTEC can be a major contributor to this process, and a global awareness of this technology is a good place to start. As a reader of this text, you are contributing to this global awareness.

*

This text closes with remarks from an article by OTEC people at the Hawaiian company Makai:

The US and the world are on a path towards a non-oil-based future and the decisions ahead are momentous. As a minimum, OTEC, which is low-risk and environmentally sustainable, should be developed in parallel with those other

technologies that appear to be economically attractive but have significant environmental risks attached. Technically, environmentally and economically – not considering OTEC is a risk the world can not afford to take. (Van Ryzin et al. 2005)

Petter Dessne works at the University of Borås, Sweden. He is the founder of OTEC Africa, organizer of the OTEC Africa Conference 2013, and editor of *OTEC Matters*.

References

- Avery, W. H., Richards, D., Dugger, G. L. (1985). Hydrogen generation by OTEC electrolysis, and economical energy transfer to world markets via ammonia and methanol. *International Journal of Hydrogen Energy*. Elsevier, pp. 727-736.
- Calnetix (2014). Calnetix Unveils Breakthrough Technology for Converting Waste Heat into Electric Power.
- DCNS Group (2014). Akuo Energy and DCNS awarded European NER 300* funding: a crucial step for the marine renewable energy sector. *DCNS Group*.
- Debez, A., Huchzermeyer, B., Abdelly, C. & Koyro, H.-W. (2011). Current Challenges and Future Opportunities for a Sustainable Utilization of Halophytes. In: Öztürk, M., Böer, B., Barth, H.-J., Clüsener-Godt, M., Khan, M. A. & Breckle, S.-W. (eds.) *Sabkha Ecosystems*. Springer Netherlands, pp. 59-77.
- Garrison, T. (2007). *Oceanography: An Invitation to Marine Science*. 6th ed. Belmont, CA: Thomson Learning.
- Golmen, L. G. (2014). Nyhamna og spillvarmen. *Romsdals budstikke*, 2014-08-08.
- Golmen, L. G. & Masutani, S. M. (2000). Combining ocean sequestration of CO₂ and OTEC: A win-win solution? *GHGT-5 Conference*.
- Golmen, L. G., Masutani, S. M. & Ouchi, K. (2005). Ocean Thermal Energy Conversion and the Next Generation Fisheries. Imbabi, M. S. & Mitchell, C. P., red. *World Renewable Energy Congress (WREC 2005)*. Elsevier.
- Hammar, L. (2011). *Towards Technology Assessment of Ocean Energy in a Developing Country Context*. Göteborg: Chalmers University of Technology.
- Johnson, T. (2013). Keynote speech: OTEC in Africa and Commercializing/Financing OTEC. *OTEC Africa Conference 2013*, 2014-10-15 Borås, Sweden.
- Lockheed Martin (2014). Tapping into the Deep Blue for Green Electricity Nets Honor. *Lockheed Martin*.
- NASA (2012). APOD 2012: December 7 - Earth at Night.
- National Oceanic and Atmospheric Administration (2008). Study Shows Ocean “Deserts” are Expanding. http://www.noaanews.noaa.gov/stories2008/20080305_oceandesert.html [2014-03-05]
- Ocean Thermal Energy Corporation (2014a). Current Projects. *Ocean Thermal Energy Corporation*.
- Ocean Thermal Energy Corporation (2014b). Future Initiatives. *Ocean Thermal Energy Corporation*.

Ocean Thermal Energy Corporation (2014c). Media Center. *Ocean Thermal Energy Corporation*.

United Nations (1979). *Manganese Nodules: Dimensions and Perspectives*. New York: UN Ocean Economics and Technology Office.

Van Ryzin, J., Grandelli, P., Lipp, D. & Argall, R. (2005). The hydrogen economy of 2050: OTEC driven? *OCEANS 2005 MTS/IEEE*, 3, 2005. IEEE, pp. 2675-2682

Vega, L. A. (2002/2003). Ocean Thermal Energy Conversion Primer. *Marine Technology Society Journal*, 6(4), pp. 25-35.

Vega, L. A. (2010). Economics of Ocean Thermal Energy Conversion (OTEC): An Update. *Offshore Technology Conference*.

Fresh Water from Ocean Thermal Energy

Vicente Fachina, Petrobras, Brazil

Introduction

This study proposes a hybrid energy farm for supplying fresh water to the northeast region of Brazil, as a long-term strategy against the chronic scenario of lack of fresh water in this century (IPCC, 2013). As a legal reference for full availability of fresh water worldwide, the United Nations has established the following resolution (United Nations, 2010):

The human right to fresh water stems from the right to adequate standards of living, which are indissolubly related to the right to the highest physical and mental standards, as well as to the right to human dignity.

The OTEC¹ principle is conceptually similar to the geothermal one. Both ones are characterized for utilizing vapor power cycles. In the tropics, the heat source is the surface seawater, and the heat sink is the deep cold seawater from below 800 m depth. Investments on OTEC are high² for the larger pieces of equipment needed to convert into electricity the low density thermal energy of the tropical seas. Nonetheless, there are two expectations for economic consideration:

1. 90 % energy availability factor (Avery & Wu, 1994), since OTEC does not present problems such as the intermittency of direct solar energy or wind power or rain, or seasonality in hydropower and bio-fuels, and;

¹ OTEC – Ocean Thermal Energy Conversion

² Investments on first-generation assets are estimated to range from 5 to 10 MUSD/MW for offshore units with net power equal or larger than 50 MW (Vega, 2010).

2. Multi-product economics, with other deliverables besides electricity, such as desalinated water, and cold water for air conditioning systems or aquaculture (Lennard, 2004).

Cornelia et al. (Cornelia & Davis, 2012) carried out a comparison study for the renewable energy supply options in the oceans, and the conclusion was that the OTEC route is the best fit for a scenario of high energy and carbon prices. Such expectations may provide competitive economic performance indicators in locations with no access to hydropower, or with high fuel costs for thermal power plants or fresh water demand. Oceanic islands or tropical coastal regions may benefit from the OTEC deliverables. In case of possible artificial islands or ocean cities in a distant future scenario, OTEC may be one of the components in a renewable energy portfolio, together with offshore wind power, solar power, and power derived from currents and waves.

OTEC – History summary

In 1881, Jacques D'Arsonval (D'Arsonval, 1881) proposed the harnessing of the stored thermal solar energy in the seas. In 1930, a D'Arsonval's student, Georges Claude (Claude, 1931), built the first OTEC unit in Cuba, which delivered 22 kWe³ from a low pressure steam turbine.

In 1931, Nikola Tesla (Tesla, 1931) published an article entitled “Our Future Motive Power” that described how to harness the geothermal and hydrothermal energy. Tesla concluded that the extension of the required engineering work for harnessing those energy forms was unfeasible at that time.

In 1935, Georges Claude built an OTEC unit onboard a 10,000 ton cargo ship anchored close to the Brazilian coast. Climate conditions and large waves wrecked the ship before the OTEC unit had started delivering electricity.

In 1962, J. Hilbert Anderson and his son James H. Anderson Jr. (Anderson, 1982) focused their research on maximizing the energy

³ The term kWe stands for *kilowatts electrical* and indicates the net electrical power, that is, the power transported to the electrical grid.

performance of the key components of an OTEC unit. They patented a new design for a closed power cycle in 1967.

In 1973, the Tokyo electrical company (TEPCO) built and installed a 100 kWe closed-cycle OTEC unit in the Nauru Island. That unit was commissioned in 1981 and delivered about 120 kWe, of which 30 kWe were dispatched to a school and other neighborhood (Xenesys, 2013).

In 1974, USA got involved in the OTEC route (NELHA, 2013). Hawaii is the best location in US for an OTEC unit because of the high sea surface temperatures, access to deep cold water, and high fuel costs.

In 2013, a 50 kWe OTEC pilot-plant was launched in the Kumejima Island, in Okinawa-Japan, (Xenesys, 2013).

OTEC – Estimation of energy resource

Hydrothermal energy stems from solar heating of the surface ocean water. The qualification of such energy resources as reserves depends on natural, local, technological, and commercial conditions. Based on the total area of the tropical seas, about 60 million km² (Avery & Wu, 1994), there exists an available 220 EJ/yr (7 TW) theoretical energy resource (Nihous & Rajagopalan, 2013), based on the direct equivalence method (Fisher & Nakicenovic, 2007), which represents 44 % of the primary energy

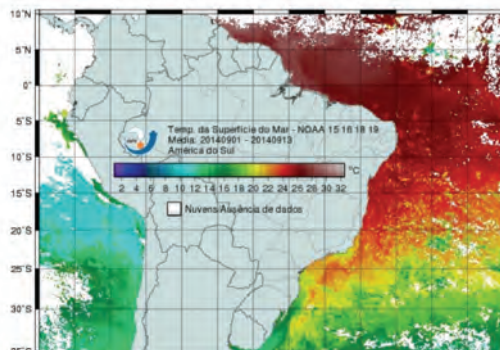

Figure 1. Mean surface ocean water temperatures (INPE, 2014). Used with permission.

consumption of the world's population (IEA, 2012). In terms of energy density, this is about 116 kW/km^2 . Figure 1 maps out the mean temperatures of the surface ocean water close to the Brazilian coastline, which favors the OTEC route.

Figure 2 shows a high aggregated boundary of an OTEC system. Useful energy can be harnessed from a temperature difference between surface ocean water and deep ocean water.

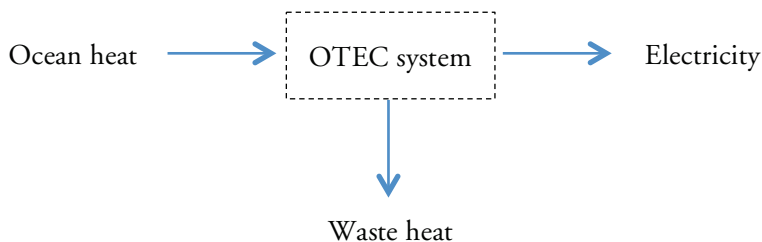

Figure 2. An OTEC system.

Figure 3 shows a numerical simulation. For instance, at 299 K (26 C) SOW^4 and 279 K (6 C) DOW^5 temperatures, the SOW exergy⁶ is about 2.8 MJ/m^3 . The system design and operation ought to minimize exergy waste and destruction along the process chain for electricity generation. The overall design and installation goal is to maximize the global exergy efficiency of the thermodynamic power cycle.

OTEC – A power cycle

Figure 4 illustrates a concept design of a thermodynamic power cycle with an ammonia–water working fluid, based on R&D by Kalina (1982), and by Uehara et al (2002).

⁴ SOW: Surface Ocean Water

⁵ DOW: Deep Ocean Water

⁶ Exergy is the very maximum useful energy which can be harnessed from an energy quantity, and it depends on a standard environmental reference as a ground-zero energy state.

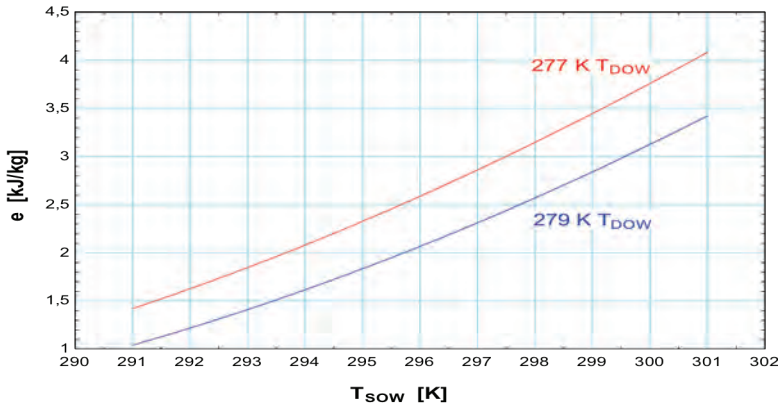
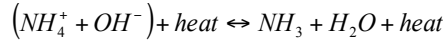

Figure 3. SOW exergy. Author's simulation.

The reasoning for utilizing a binary working fluid, instead of a pure substance in a traditional Rankine cycle, is to maximize energy performance through the energy balance of such a mixture, as seen in the equation below.



In the evaporator-separator system, surface seawater exchanges heat with an ammonia-water mixture: heat vaporizes ammonia (endothermic reaction), and heat superheats it, which increases energy performance (in a Rankine cycle, there is latent heat exchanging only). After the evaporator-separator system, superheated vapor flows toward the turbo-generator. Such a vapor is mostly a NH_4^+ ionic compound.

The turbo-generator converts a fraction of the superheated vapor enthalpy into electricity. After the turbo-generator, saturated vapor is discharged in the absorber-condenser system. In the absorber-condenser system, water from the regenerator is mixed with saturated vapor from the turbo-generator discharge: through removal of heat in the absorber (exothermic reaction), and more heat in the condenser, a sub-cooled liquid is formed, which is then pumped to the regenerator. Such a sub-cooled liquid is a $NH_4^+ + OH^-$ ionic compound.

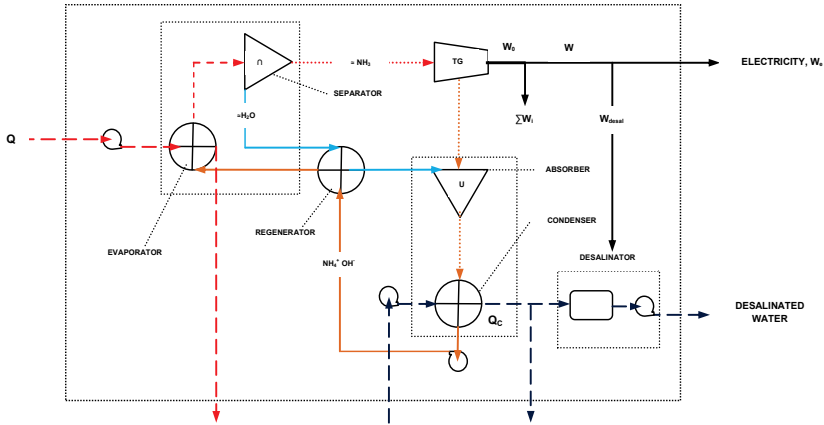

Figure 4. Schematics of a closed power cycle OTEC with seawater desalination.

In the regenerator, water from the separator preheats the sub-cooled liquid, which then flows to the evaporator-separator system, and the cycle repeats itself. A seawater desalination system to use the reverse osmosis technology is included with utilization of deep ocean water.

Context for economic analysis

Citing Camdessus et al. (2004):

“The notion of adequate water supply should be interpreted compatibly as to human dignity and not in a narrow sense by simply referring to quantity criteria or technical aspects. Water should be considered as a social and cultural asset and not an economic one only. The right to water should also be due in a sustainable scenario, in order to current and future generations benefit from it.”

On such a context, the premise of public agents to participate becomes fundamental, and the participation of private agents is to promote better business efficiency by proper public regulation. As to the origins of resources, it may happen two to two and half billion dollars annually (Goldemberg, Schaeffer, Szklo, & Lucchesi, 2013), to stem from the oil and

gas sector within and beyond the 2020 decade for investing in renewable energy routes in Brazil.

Economic analysis for first-generation assets

When discussing OTEC economics, it is important to both find out how to perform calculations on the financial feasibility of an OTEC plant, and to have an understanding of the cost structure of OTEC plants in general. This section covers these two parts. Also, it sets the stage for analyzing a hybrid OTEC/wind energy farm for fresh water delivery.

Performing calculations on OTEC financials

By assuming an investment setup with public-private partnerships, the author has considered a discounted payback of five years for a 200 MW asset an acceptable threshold for private agents. The analysis excludes the costs of the water pipe lines. The basic parameters for the analysis are:

- Useful life: 25 years;
- Capital cost: 10 %/yr, and 20 %/yr;
- Carbon price⁷: £85/t CO_{2e}, 2033 scenario (UK Government, 2010);
- Fresh water price⁸: 0.8 USD/m³ for 200 MW;
- Electricity price⁹: 56 USD/GJ for 200 MW;
- Energy availability factor: 90 % (Avery & Wu, 1994);
- All USD values as to the 2010 reference.

On the cash flows, the author has disregarded effects such as fiscal, finance, insurance or residue values. Table 1 shows the formulas for calculations on OTEC financials. The first equation is an optimization function representing a null present-worth value, which is a condition for determining the participation levels of public agents, C_p , in order to satisfy

⁷ The emission factor is 130 kg_{CO_{2e}}/GJ (468 g_{CO_{2e}}/kWh) for natural gas (IPCC, 2011).

⁸ The value 3.0 USD/m³ refers to the price in Fernando de Noronha/PE in 2013; the value 0.8 USD/m³ lies within the range from SNIS (SNIS, 2011).

⁹ The value 139 USD/GJ refers to the price in Fernando de Noronha/PE in 2013; the value 56 USD/GJ is an average opportunity cost for offshore wind power (IPCC, 2011).

the restriction of the payback time, t^* , for the private agents. The second equation in the model is the capital investment, which is valid for first-generation OTEC assets only (Vega, 2010). The third equation represents an investment cash flow over a time period, m , after which the operation phase begins. The product prices, quantities and costs are pr_i , q_i e $c(q_i)$, respectively. A positive externality to consider in the values of pr_i and q_i may be a carbon price.

The author has assumed a nominal yearly interest rate of 20 % from the beginning of the basic design phase (time = $-m$) until the 5th year from the beginning of operation, in order to simulate a market interest rate for higher uncertainties; from the 6th year until the 25th one, the author has assumed a nominal yearly interest rate of 10 %, in order to simulate a market interest rate for lower uncertainties. Such assumptions are based on interest rates used by typical investment agents (Swisher, Jannuzzi, & Redlinger, 1997).

Table 1. Modelling for the OTEC financials.

Target function	Restrictions
$\sum_1^{t^*} \left[\sum_t pr_i q_i - c(q)_i \right] x^{-t} - \sum_{-m}^0 (1 - C_p) I_t x^{-t} = 0$	$t^* \in \{5, 10\}$ $0 < C_p < 1$
$I(w) = a_0 w^{1-\lambda}$	$x = 1 + j$
$I = \sum_{-m}^0 I_t$	$\therefore t \in [-m, +5] \rightarrow j = 20\%$ $\therefore t \in [+6, +25] \rightarrow j = 10\%$

The cost structure of OTEC plants

Table 2 shows a cost breakdown for first-generation OTEC plants (Lennard, 2004). The power cycle is a closed one as of Figure 4.

Table 2. Cost breakdown in MUSD for first-generation assets.

Scope item	Percent	MUSD, 200 MW plant
Defining installation location	2	15.51
Heat exchangers	21	162.86
DOW pipeline	13	100.82
Mooring	5	38.78
Electrical cabling	9	69.80
Process plant	19	147.35
Naval structures	22	170.61
Installation	5	38.78
Commissioning	4	31.02
Desalination system		100.00
Total in MUSD		\$875

Modelling of a hybrid energy farm for fresh water

As a potential long-term solution for the increasing supply risk of fresh water on the planet, as projected by the UN/IPCC (IPCC, 2013), the author has proposed a concept design of a hybrid offshore energy farm, comprising both OTEC and wind power units, to supply desalinated seawater to the northeast region of Brazil. Neither OTEC nor offshore wind power alone may suffice, that is why a hybrid setup may comply with the projected fresh water demands, and with minimum levelized costs.

Figure 5 illustrates a conceptual layout of an energy farm with a total area, A , to satisfy technical, environmental or geopolitical constraints. The circles represent unit areas, in whose centers the power units should be installed in order to comply with the constraint imposed by an available energy density, p . The minimum distance among the power units can be preliminarily modeled as the diameter, \square , which is a function of the available energy density, p , shown in the equation below.

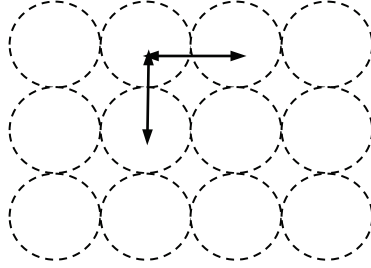

Figure 5. Concept layout (horizontally, not to scale) of an energy farm.

$$\frac{\pi\phi^2}{4} = \frac{w}{p} \rightarrow \phi = 2\sqrt{\frac{w}{\pi p}}$$

Table 3 shows formulas for calculations on OTEC/wind power farm. Four variables to optimize for minimum levelized total cost, C: a) the quantity of OTEC units; b) the quantity of wind units; c) the OTEC net power; d) the wind net power. The nominal power values and quantities ought to be within defined ranges, out of which their implementations are not feasible, either technically or economically.

The upper thresholds for the quantities of units can be estimated by either economic or environmental constraints. Follows the legend:

- h : subscript for hydrothermal;
- w : subscript for wind power;
- C: total levelized cost of desalinated seawater [USD/m³];
- B: desalinated seawater consumption [m³/s];
- c: levelized cost of desalinated seawater [USD/m³];
- d: desalinated seawater supply [m³/s];
- n: quantity of units;
- n^{max}: maximum quantity of units;
- w: net power of each unit [MW];
- w⁰: nominal power of each unit [MW];
- w^{min}: minimum nominal power of each unit [MW];
- w^{max}: maximum nominal power of each unit [MW];

- ♦ A : available installation area [km^2];
- ♦ p : energy density [MW/km^2];
- ♦ β : specific energy consumption for fresh water [MJ/m^3];
- ♦ ε : levelized cost of electricity (LCOE) [$\$/\text{MJ}$];
- ♦ α : electricity availability factor [1].

Demand side: the social and technical boundary conditions

The projected demand of fresh water by 2025 for the northeast region of Brazil for human consumption only is $198 \text{ m}^3/\text{s}$ (ANA - Agência Nacional de Águas, 2006). Based on the IBGE report (IBGE, 1996), the author has assumed an average demographic annual rate increase of 1 % in the northeast region of Brazil for the 2025-2050 time frame, after which it becomes flat, with $254 \text{ m}^3/\text{s}$ projected human consumption due to energy efficiency actions (MME, 2011).

For the simulation of the OTEC power cycle, the author has utilized a software tool for thermodynamic calculations on an ammonia-water binary working fluid (Figure 4). The premises are:

- ♦ Specific energy consumption for desalination (ref. value): $18 \text{ MJ}/\text{m}^3$ (Ouchi, Jitsuhara, & Watanabe, 2011);
- ♦ Average length of water pipe lines from the offshore units to the coast: 30 km;

Table 3. Modelling for the OTEC/wind power farm.

Target function	Restrictions
$Min \rightarrow C = c_h d_h + c_e d_e$	$d_h + d_e \geq B$
$d_h = \frac{n_h w_h}{\beta_h}; d_e = \frac{n_e w_e}{\beta_e}$	$0 \leq n_h \leq n_h^{\max}, n_h \in \mathbb{N}$
$c_h = \beta_h \varepsilon_h; c_e = \beta_e \varepsilon_e$	$0 \leq n_e \leq n_e^{\max}, n_e \in \mathbb{N}$
$w_h^0 = \frac{w_h}{\alpha_h}; w_e^0 = \frac{w_e}{\alpha_e}$	$w_h^{\min} \leq w_h^0 \leq w_h^{\max}$
	$w_e^{\min} \leq w_e^0 \leq w_e^{\max}$
	$n_h w_h^0 \leq A_h p_h$
	$n_e w_e^0 \leq A_e p_e$

- ♦ Average pumping head (sea surface = 0) from the offshore units to the distribution units in the coast: 5 m.

Results and discussions

Based on the premises below, 26 USD/GJ (95 USD/MWh) levelized cost of electricity is found for a 200 MW OTEC asset only.

1. About half a billion USD investment for a 200 MW plant with a desalination unit, 5-year implementation of each plant (from concept design to start-up), and a 30-year market learning curve;
2. About MUSD 16/yr reference operational and maintenance cost (Ouchi, Jitsuhara, & Watanabe, 2011).

Figure 6 shows returns over investment at both 10 %/yr and 20 %/yr for one 200 MW OTEC plant only. The central curve represents the expected cash flows, and the others represent some allowable tolerances. About 52 % public investments are needed in order to enable a five-year maximum payback for private agents.

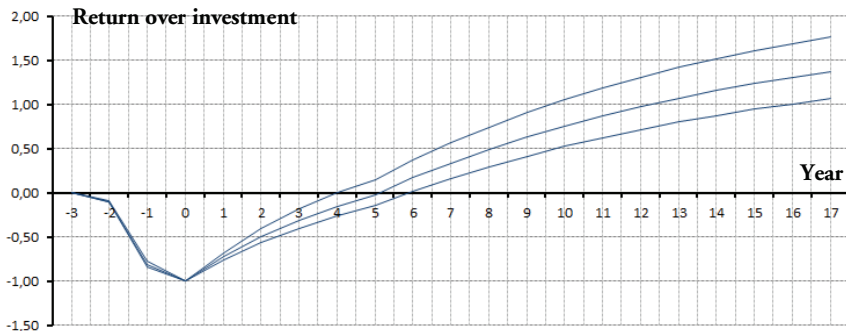

Figure 6. Returns over investment on a first-generation 200 MW OTEC plant. Author's simulation.

A hybrid energy farm for fresh water

For the OTEC route only, 0.5 USD/m³ levelized cost of fresh water stems from multiplying the levelized cost of electricity, 26 USD/GJ, by the specific energy consumption for fresh water, about 19 MJ/m³, which is obtained by

adding the specific energy for desalination to the specific energy for pumping fresh water up to the coast.

For offshore wind power only, 47 USD/GJ (170 USD/MWh) levelized cost of energy stems from the median value out of the cost range for the offshore wind power (IPCC, 2011). The energy density for the offshore wind power, 4 MW/km², is taken as twice the value from the onshore wind power, which in turn stems from the *Atlas do Potencial Eólico Brasileiro* (Amarante, Zack, & Sá, 2001).

By adding 1.8 MUSD/MW offshore wind power investment (IPCC, 2011), the grand total investment is about USD 16.5 billion, excluding the fresh water pipe lines, for the whole energy farm. That amount might stem from the oil and gas rents within and beyond the 2020 decade in Brazil (Goldemberg, Schaeffer, Szklo, & Lucchesi, 2013).

By assuming 16 hours of daily fresh water consumption, the annual one results about 5.3 billion m³, with a total levelized cost of fresh water of

Table 4. Simulation results of an energy farm for seawater desalination.

Description	Units	OTEC	Wind
Number of units, n	[1]	26	108
Unit net power, W	[MW]	102.5	19.6
Electricity availability factor,	[1]	0.513	0.980
Unit gross power, W0	[MW]	200	20
Total gross power, nW0	[MW]	5,200	2,160
Levelized cost of electricity	[USD/MJ]	0.0263	0.0472
Levelized cost of fresh water	[USD/m3]	0.496	0.889
Energy density, p	[MW/km2]	0.116	4.000
Available area, A	[km2]	100,000	100,000
Available capacity, Ap	[MW]	8,333	400,000
Min gross power, Wmin	[MW]	50	5
Max gross power, Wmax	[MW]	200	20
Specific energy for fresh water	[MJ/m3]	18.83	18.83
Unit min distance	[km]	39.6	2.0
Fresh water supply per route	[m3/s]	141.6 (55.75 %)	112.4 (44.25 %)
Total cost	USD		\$5.4B/yr

1.0 USD/m³, which is below the current average cost of fresh water in the northeast region of Brazil (SNIS, 2011). Table 4 shows the simulation results for fresh water supply in the northeast region of Brazil.

Figure 5 shows the frontiers of the Brazilian northeast continental shelf (red perimeter), 1,000 km long, at 10 km to 50 km distance to coast, beyond which begins the oceanic region. The installation sites for the OTEC units, around 100,000 km², should be alongside that perimeter.

Conclusions

The OTEC route dates back from the final of the 19th century, and it has gained new momentum on the 21st century due to rising oil prices, and environmental concerns.

The economics for a 200 MW OTEC plant results 95 USD/MWh LCOE, with about half billion USD investment after a 30-year market learning curve.

A hybrid energy farm comprising of both OTEC and wind power units has been modeled in order to provide fresh water for human consumption in the northeast region of Brazil by 2050 onwards, and found 1.0 USD/m³ minimum levelized cost of desalinated seawater.



Figure 5. Perimeter for the OTEC/wind energy farm. Source: Author/Google Earth. Map data: Google & MapLink, 2013. Used with permission.

The next study shall be a concept project for implementing a subsea¹⁰ OTEC pilot plant for supplying electricity at the Fernando de Noronha island, about 545 km offshore in the northeast coast of Brazil.

As with all new energy technologies, long-term public funding and adequate regulatory support are fundamental. With long-term acceptance by society, accumulated knowledge, large scale economics and environmental concerns, costs should go down, and the OTEC technology should be a viable option in the coming decades.

Vincent Fachina works for Petrobras, Brazil. He may be contacted at vicentefachina@gmail.com.

¹⁰ An installation in which surface ocean water moves through an insulated HWP (hot water pipe) downwards deep sea, where the OTEC plant is to be installed.

References

- Amarante, O., Zack, M., & Sá, A. (2001). *Atlas do Potencial Eólico Brasileiro*. Ministério de Minas e Energia.
- ANA - Agência Nacional de Águas. (2006). *Atlas Nordeste - Abastecimento Urbano de Água*.
- Anderson, J. (1982). *Ocean Thermal Power – The Coming Energy Revolution*.
- Avery, W., & Wu, C. (1994). *A Guide to OTEC*. Oxford University Press.
- Camdessus, M., Badré, B., Chéret, I., Frédéric, P., & Buchot, T. (2004). *Eau*. Paris: Editions Robert Laffont.
- Claude, G. (1931). Power from the Tropical Seas. *Mechanical Engineering*, pp. 52:1039-1044.
- Cornelia, N., & Davis, R. (2012). Renewables - Ready or Not? *Offshore Technology Conference*, p. 23138.
- D'Arsonval, J. A. (1881). Utilisation des Forces Naturelles Avenir del'électricité. *Revue Scientifique*, pp. 17:370-372.
- Fisher, & Nakicenovic. (2007). *Issues related to mitigation in the long term context*. Cambridge, UK: Cambridge University Press.
- Goldemberg, J., Schaeffer, R., Szklo, A., & Lucchesi, R. (2013). Can the petroleum industry pave the way for renewables in Brazil? *ELSEVIER/Energy Policy*.
- IBGE. (1996). *Divisão de Estudos e Análises da Dinâmica Demográfica*.
- IEA. (2012). Acesso em 2012, disponível em International Energy Agency: [iea.org](http://www.iea.org)
- INPE. (2014). *Oceanografia por satélite*. Acesso em 2014, disponível em <http://satelite.cptec.inpe.br/tsml/>
- IPCC. (2011). *Special Report on Renewable Energy Sources and Climate Change Mitigation (SRREN)*.
- IPCC. (2013). *Working Group I Contribution to the IPCC Fifth Assessment Report_Summary for Policymakers*.
- Kalina, A. (1982). *Patente Nº 4,346,561*. USA.
- Lennard, D. (2004). Ocean Thermal Energy. In: *Encyclopedia of Energy* (p. Volume 4). Kent, United Kingdom: Elsevier.
- MME. (2011). *Plano Nacional de Eficiência Energética (PNEf)*.
- NELHA. (2013). Acesso em 2013, disponível em Natural Energy Laboratory of Hawaii Authority: <http://nelha.hawaii.gov>

- Nihous, G., & Rajagopalan, K. (2013). Estimates of global Ocean Thermal Energy Conversion (OTEC) resources using an ocean general circulation model. *Elsevier/Renewable Energy*, 50 (2013) 532e540.
- Ouchi, K., Jitsuhara, S., & Watanabe, T. (2011). Concept design for offshore DOW platform as infra-structure of isolated island. *OMAE*, pp. 2011-49128.
- SNIS. (2011). *Diagnóstico dos Serviços e Água e Esgotos*. Brasília-DF: Ministério das Cidades.
- Swisher, J., Jannuzzi, G., & Redlinger, R. (1997). *TOOLS AND METHODS FOR INTEGRATED RESOURCE PLANNING*. UNEP.
- Tesla, N. (1931). *Our Future Motive Power*.
- Uehara, H., Ikegami, Y., & Noda, N. (2002). Extraction condition of OTEC using the Uehara cycle. *Twelfth International Offshore and Polar Engineering Conference*.
- UK Government. (2010). *Carbon Values Beyond 2050*. Fonte: https://www.gov.uk/government/uploads/system/uploads/attachment_data/file/48108/1_20100120165619_e____carbonvaluesbeyond2050.pdf
- United Nations. (2010). Resolution Recognizing Access to Clean Water, Sanitation as Human Right. *GA/10967* (pp. Sixty-fourth General Assembly Plenary / 108th Meeting (AM)). New York: UN Department of Public Information.
- Vega, L. (2010). Economics of Ocean Thermal Energy Conversion (OTEC): An Update. *Offshore Technology Conference*, p. 21016.
- Xenesys. (2013). *Xenesys*. Acesso em 17 de Feb de 2014, disponível em Xenesys: <http://www.xenesys.com/english/products/trackrecord.html>

OTEC in the TROPOS Multipurpose Platform Concept

Dr. Lars G. Golmen, Runde environmental centre/Norwegian Institute for Water Research (NIVA), Norway,

Dr. Jason C.S. Yu, National Sun Yat-Sen University, Taiwan,

& Dr. W. Chen, NIVA, Norway

Abstract

The key objective of the on-going TROPOS project is the development of a floating modular multi-use platform system for use in deep waters with an initial geographic focus on locations of Crete (Greece), Gran Canaria and Taiwan. The TROPOS multi-use platform system will be able to integrate a range of functions from the Transport, Energy, Aquaculture and Leisure sectors. A core part of the project addresses Environmental and Socio-Economic Impact Assessment (EIA, SIA) from the construction and siting of the platform, that are assessed through common schemes for all locations (international regulations), and then adapted to the pending national and local regulations. This presentation describes the procedures and some results from these assessments.

Introduction

Most of the world population congregates along coasts and in nearby inland communities. The coastal environment is under pressure from anthropogenic pollution sources, expanding industrial activities and transportation, with water quality and biodiversity at stake, while climate change and sea level rise brings more fuel to the fire. The outlook for the present century regarding world population growth looks more grim than previous projections, with figures for 2100 now as high as 12.3 billion [1]. Evidently, this will put an even larger pressure on the coasts, and it will be

necessary to take actions to alleviate the situation in many countries and regions. The ocean may provide the necessary space and resources for this.

Under the 7th Framework program, the EU launched the a call “Ocean of Tomorrow”, asking for proposals how to combine specific coastal activities and move those to offshore locations. The proposal named "TROPOS" that got funded under – Multi-use offshore platforms, and lead by the Spanish institute PLOCAN, is about designing a floating modular, multi-use platform system (Fig. 1) for use in deep waters, with an initial geographic focus on locations of Crete (Greece), Gran Canaria and Taiwan [2, 3]. The project period is 2012-2015 and the TROPOS approach is centered on the modular development (also satellite units have later been incorporated, in order to increase the flexibility and expand the scope). In this way, the flexible TROPOS multi-use platform system is able to integrate a range of functions from the Transport, Energy, Aquaculture and

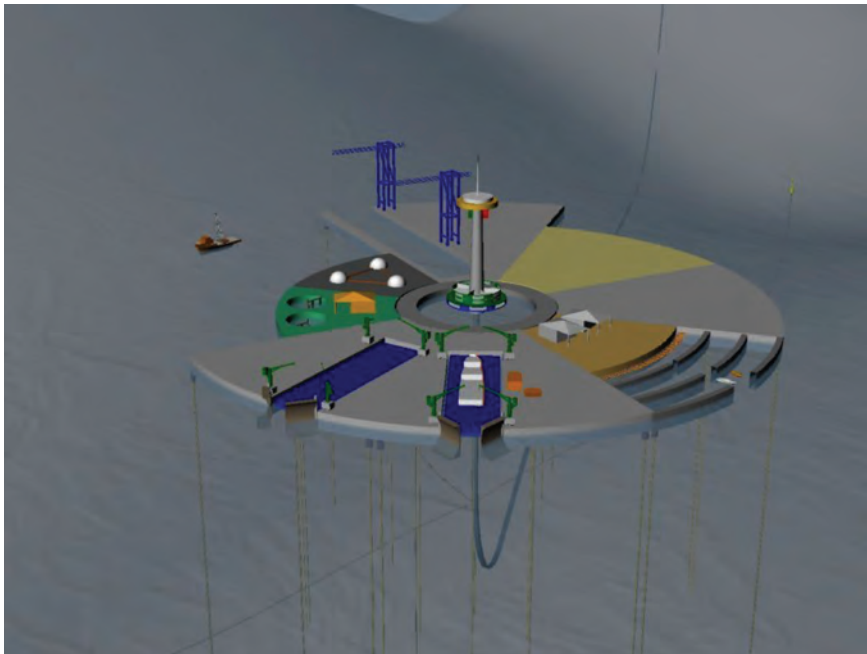

Figure 1. Sketch of the TROPOS platform, with a central unit and modules that can be replaced.

Leisure sectors (named as TEAL components in the project, Fig. 2).

Besides the many technological aspects, The project also addresses Environmental Impact Assessment (EIA) and Socio-Economic Impact Assessment (SIA) from the construction, placement and operation of the platform, that are assessed through common schemes for all locations (international regulations), and then adapted to the pending national and local regulations. The approach in TROPOS for the development of a legislative and normative framework for multiuse offshore platforms, is to extrapolate and extract from legislation, standards and experience for single-use structures. That is, to evaluate and compare environmental impacts between single-use, dual-use and multi-use designs and describe gaps in the present methodology, legislation and norms, and, finally, suggest improvement/amendments to present applicable legal regimes.

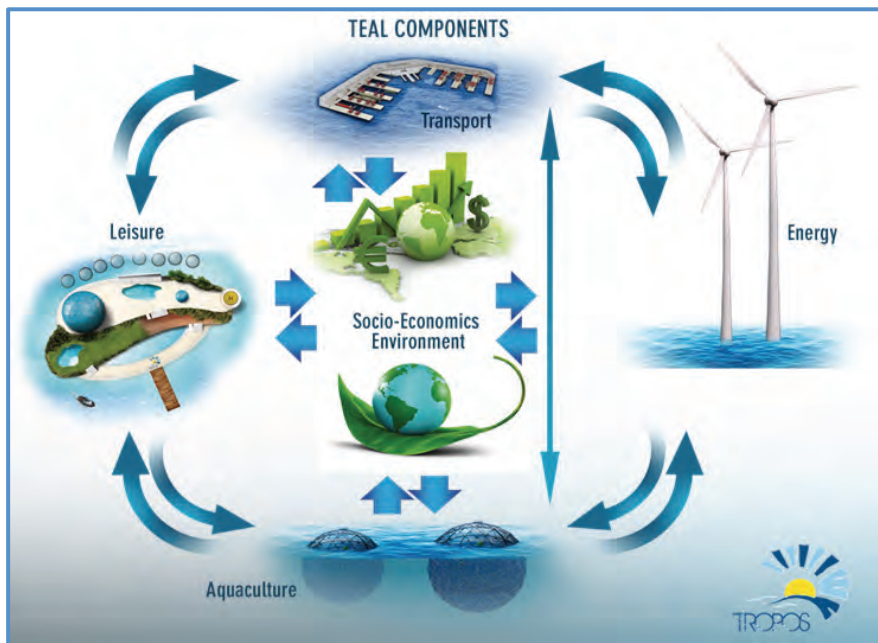

Figure 2. The TROPOS platform can accommodate modules for Transport, Energy, Aquaculture and Leisure sectors (named as TEAL components in the project).

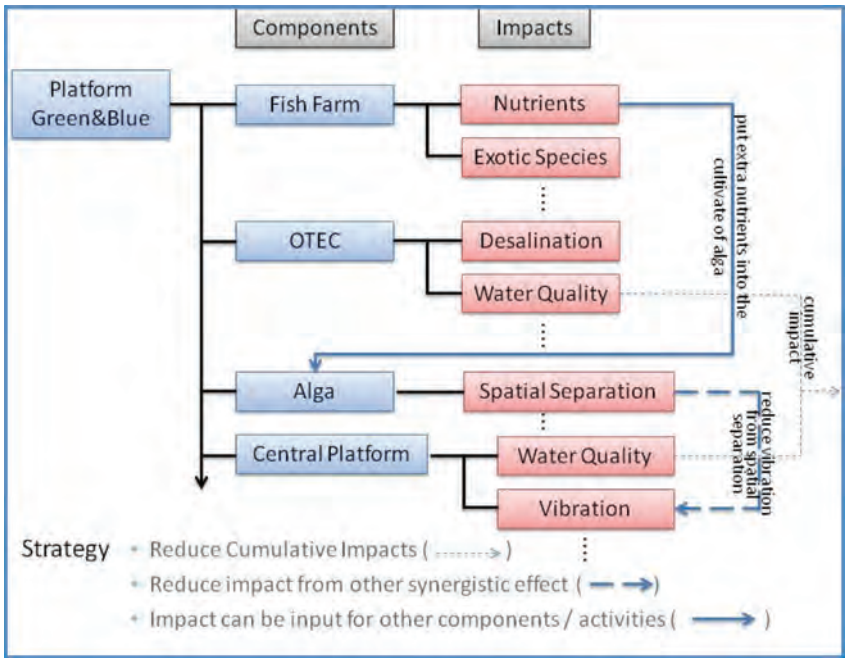

Figure 3. A flow chart showing the relations between various compartments of the TROPOS concept, and how impacts can be managed and reduced.

The Energy component in TROPOS consists of renewable ocean energy technologies only, and OTEC is one such component, in addition to wind, solar, waves. Besides the production of electricity, OTEC has the benefit that it can generate fresh water and provide nutrient-rich deep water for aquaculture purposes. Aquaculture also can receive waste flows from other compartments on the platform, and in this respect, minimize the environmental impact. The project looks at various ways to manage the waste streams and reuse material (Fig. 3).

OTEC in TROPOS

The working principles of OTEC is described in other papers of *OTEC Matters*, and will not be repeated here, we just point out the main components, as described in the text box below.

The most bulky part is the **pipeline** needed to retrieve the cold deep waters, at depths of 600 m or more. Also, the **heat exchangers** are bulky, as the low Delta-T requires a substantial exchanger area. **Pumps** are required to the seawater flows and for the driving fluid flow. A **turbine** is required to extract the power, which is converted to electricity by the **generator**. These five high-lighted items are the most bulky parts of the plant. Naturally, the plant needs a **foundation** to rest on, an enclosure or **housing**, and, for the TROPOS case, a **floating platform** with sufficient carrying capacity to handle the weight of the plant, and all the other components of TROPOS. Then there are miscellaneous smaller parts, pipes and valves, sensors, the **discharge pipe**, control panels, **power outlet** connection, and a **sea cable** to carry electricity to shore.

According to the initial studies, the area is off the SW coast of Taiwan provides adequate conditions for OTEC, particularly in the Kaohping undersea canyon (Figure 2), with depths beyond 600 m close to the small island. The temperature difference between the surface and the deep layer at the Kaohping Canyon site is 15 °C at 300 m depth. Larger differences will be obtained by going deeper off the shelf edge, where OTEC criteria will be met. (The two other locations, near Crete and Gran Canaria, did not meet the temperature difference criteria.)

OTEC with Closed Cycle has advantages relative to the Open cycle, such as simpler construction, more state-of-the-art/off-the-shelf components, more recent designs available (most present OTEC plans seem to be with C C), less parasitic loss from compressors, and most likely lower CAPEX price, compared to O C. Disadvantages will be the use of a foreign substance, ammonia, as working fluid, and no direct production of fresh water. Ammonia can go astray in e.g. in leak situations and will then

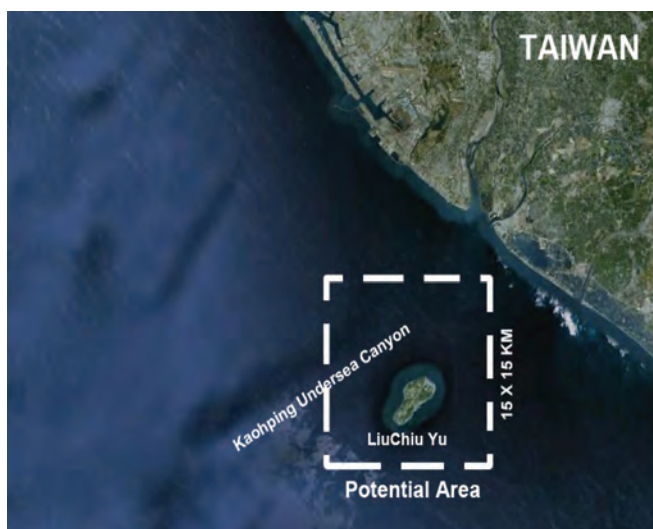

Figure 4. The TROPOS site for Taiwan is in the Kaohping Undersea Canyon, near the LiuChiu island on the SW coast, off Kaohsiung city.

represent an HSE risk. This risk will be low and manageable, as there is a vast experience from handling ammonia, which is in widespread use in the industry today (refrigeration etc). Fresh water can be produced in a second stage by evaporation or by reverse osmosis. Therefore, the TROPOS team choose the Closed Cycle for this design stage of TROPOS.

Contrary to other renewable energy sources in TROPOS, OTEC will provide constant, base-load electricity. An analysis was made on the minimum requirements for such production, that could be met by OTEC, and an 8 MW gross, 5 MWnet, Closed Cycle OTEC plant was selected based on the following criteria:

- ♦ Compliant with the Technological Readiness Limit (TRL) requirements as stated by CRRC [4]
- ♦ Is still significant in baseload power production, compared to anticipated total demand for TROPOS
- ♦ Comparable to or larger in capacity to other power generation units for TROPOS, e.g. wind
- ♦ Can use common power export (and storage) facilities
- ♦ Still moderate in physical size

- ♦ Existing concept design is available [5]
- ♦ For future expansion, one can anticipate several power modules in parallel.

The OTEC plant is designed as a satellite unit, with compartments for the crew and a sea cable bringing the electricity to the central unit. A single point mooring system was considered, that can hold both the OTEC unit and the central unit (Fig. 5). The total weight is calculated at 17,200 tons, including, a 7.5 % uncertainty margin. This is based on a 4 MW_{gross} (2.5 MW_{net}) modular design [5], with two such modules, but where the hull is sized so that it can carry a larger, 16/10 MW plant (4 modules) in the future.

Possible relation between OTEC module and Central Unit in Tropos

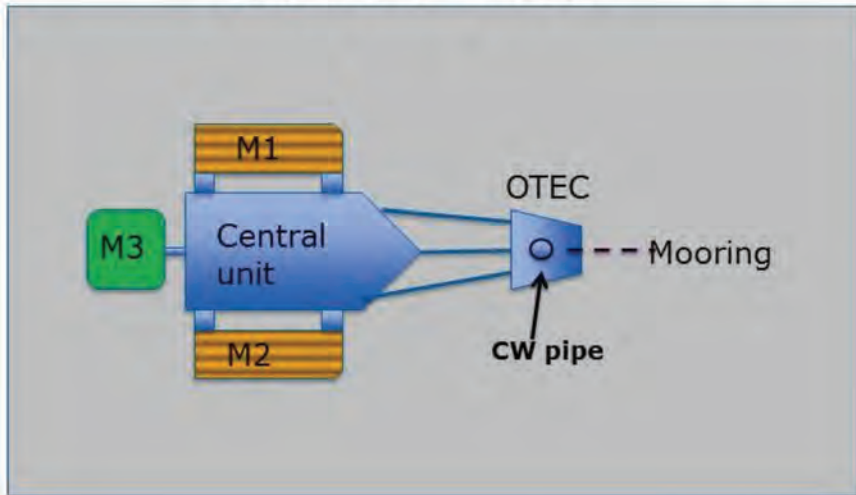

Figure 5. Illustration of how the OTEC module can act as mooring support for the Central Unit with other modules (M), with a single-point mooring, as described in [6].

The plant equipment will be distributed on two decks. The long pipes are considered as neutral in the water, i.e. no weight issue in our case (physical drag from sea currents must be considered in final design stages). Standard construction ships (e.g., tankers, container ships, FPSOs) can handle such OTEC equipment. The 8 MW_{gross} design can fit in a standard ship shape, or a designed module shape with sufficient operating displacement. For existing OTEC designs. Numbers from [5] indicate, as example, the size of a vessel to carry a 10 MW_{net} OTEC plant and based on that, our design will be a square barge-shape of ca 56 x 56 m, (17 m tall, 11 m draft).

Used cold water can be used for air conditioning in the Leisure compartments and the production and processing units in TROPOS.

There is significant potential to combine OTEC with aquaculture. The used cold seawater can be lead into enclosures for the ranching of cold water species like salmon. The nutrients in the cold water can be basis for enhanced primary production in enclosures and boost the growth of microalgae and macroalgae. Microalgae in turn, can nourish zooplankton, which becomes feed for larger species including fish. In this way, a controlled food chain can be established, with edible fish as a commercial product. This is the concept of NGF: Next Generation Fisheries.

Conclusion

The basic principles of OTEC and a preliminary design of a 2x4 MW_{gross}, 2x2.5 MW_{net} Closed Cycle OTEC plant in TROPOS is regarded as technically feasible today. The selected site for OTEC in TROPOS is Taiwan, but the concept holds potential throughout many of the tropical/subtropical regions, including the east and west coasts of Africa. During the final stage of the TROPOS project, further conclusions will be drawn, also on the launch of follow-up studies and eventual construction of a full scale, floating TROPOS platform.

Acknowledgements

The TROPOS project is funded under the EU-FP7 program “Ocean of Tomorrow”, call OCEAN 2011.1 – Multi-use offshore platforms.

We are particularly thankful for advice provided for parts of this study by Gerard Nihous, Luis Vega and Steve Masutani at the University of Hawaii and Thomas Lockhart at DCNS.

Lars Golmen is the head of Runde Environmental Centre in Norway, and has an extensive experience in OTEC research. Dr. Golmen was co-organizing the OTEC Africa Conference 2013, and is the scientific editor of *OTEC Matters*.

References

- [1] Gerland, P. et al. 2014: World population stabilization unlikely this century. *Science* 10 October 2014: Vol. 346 no. 6206 pp. 234-237.
- [2] <http://www.troposplatform.eu>.
- [3] E. Quevedo, M. Cartón, E. Delory, A. Castro, J. Hernández, O. Llinás, J. Bard, J. de Lara, H. Jeffrey, D. Ingram, N. Papandroulakis, P. Anastasiadis and J. Wesnigk, “Multi-use offshore platform configurations in the scope of the FP7 TROPOS Project”, MTS IEEE OCEANS, Bergen (Norway) 2013.
- [4] CRRC 2010: Technical readiness of Ocean Thermal Energy Conversion (OTEC). Coastal Response Research Center and Univ. New Hampshire, Durham, 22 pp + appendices.
- [5] Vega, L. 2012: Ocean Thermal Energy Conversion. *Encyclopedia of Sust. Science and Technology*, Springer, Aug. 2012 7296-7328.
- [6] Ravindran, M. 2000: The Indian 1 MW Floating OTEC plant – and overview. IEA-OES Newsletter, No 1, 2000.

OTEC advanced composite cold water pipe: An overview of its development and fabrication process validation

*Dr. Alan K. Miller,
Santa Cruz, California, USA*

Introduction and reference to full details

This is an overview of work done on this subject at Lockheed Martin Corporation through the end of 2010. Full details on that work can be found in a SAMPE paper and US Dept. of Energy report published elsewhere. Those documents are available for viewing and downloading (no charge) via the web at the following links. The current overview refers to many figures from these documents, and will best be understood by the reader if they (especially the SAMPE paper) are placed alongside.

1. Documents with introductory material by OTEC News: “Advanced Composite Cold Water Pipe”, OTEC News, July 11, 2012; available at: <http://www.otecnews.org/2012/07/advanced-composite-cold-water-pipe/>
2. SAMPE paper: “Selection and Validation of a Minimum-Cost Cold Water Pipe Material, Configuration, and Fabrication Method for Ocean Thermal Energy Conversion (OTEC) Systems,” Alan Miller, Ted Rosario, Matt Ascari, Proceedings of SAMPE 2012, Baltimore, MD, May 2012; available at: <http://www.otecnews.org/wp-content/uploads/2012/07/Lockheed-Martin-OTEC-Cold-Water-pipe-SAMPE-2012-paper.pdf>
3. US Dept. of Energy report: “OTEC Advanced Composite Cold Water Pipe: Final Technical Report”, Dr. Alan Miller; Matthew Ascari, OSTI ID: 1024183, Oct. 12, 2011; available at: <http://www.osti.gov/scitech/servlets/purl/1024183>

Elements of the processes described herein are covered by multiple US and International patents.

CWP requirements and loadings

The cold water pipe for a commercial-scale (100 MW) floating OTEC system (see figure 1 of ref. 2 above) needs to be not only 1000 m long to reach the deep cold water, but also about 10 m in diameter to handle the huge water flows required (see figure 2 of ref. 2 above). To minimize frictional losses and maximize efficiency, a large OTEC plant has only one Cold Water Pipe.

The principal loadings that must be carried with very high reliability include (see figure 3 of ref. 2 above):

- ♦ Internal suction/global net external pressure (the cold water pumps are at the surface)
- ♦ Bending fatigue and overload from wave and swell-induced motions of the floating OTEC platform
- ♦ Localized external pressure from grippers and bushings
- ♦ Axial strain from the pipe's own wet weight plus any clump weight that might be added to reduce lateral deflection by currents
- ♦ Static bending by currents
- ♦ High local seawater pressure at depth
- ♦ Seawater corrosion

CWP architecture and validation by analysis

Based on these drivers and enabled by the in-situ fabrication method selected (see below) the architecture of the pipe is as follows (see figure 5 of ref. 2 above):

- ♦ One-piece integral pipe with no macroscopic joints
- ♦ Sandwich wall with hollow core vented to seawater
- ♦ Core: Factory-pultruded hollow laminate “planks” assembled into core rings on site.

- ♦ In the final CWP design, the core planks are assembled as a staggered array, for effective load transfer without a discrete single break in core continuity (see p. 57 of ref. 3)
- ♦ Inner and outer face sheets: Longitudinally continuous fabric strips, applied over the assembled core rings.
- ♦ Each face sheet is comprised of two layers of thick stitch-assembled non-crimp fabric (see pages 63 and 64 of ref. 3). The zero-degree (axial) fibers are left out of the 76 mm/3 inches along each edge of each roll, minimizing thickness increase at the overlap edge splices (see p. 65 of ref. 3). These fabric edges overlap each other by a total of 152 mm/6 inches in order to transfer circumferential loads effectively via the 90 and +/- 45 fibers (see figure 12 of ref. 2). An early local buckling test incorporated such overlap splices into both face sheets. The specimen failed elsewhere, indicating that the overlap splices held the required loads (see figure 13 of ref. 2)

The integral one-piece CWP with no macroscopic joints maximizes durability and reliability. Elimination of macroscopic joints keeps the maximum stress concentration low, which is important for efficient fatigue design. It also eliminates the many, many interfaces that would have to be manufactured to precise dimensions if discretely manufactured sections of pipe were to be bonded and/or bolted to each other, saving greatly on cost. Of course, stepwise fabrication of an integral structure puts a premium on the reliability of fabrication during each step.

Finite-element analysis was used to analyze various possible shapes for the core cells. It was found that triangular core cells (see Figure 10 of ref. 2) provided the best net external pressure resistance and an ample margin against global collapse. The CWP design also provides adequate margin against local buckling under gripper and bushing pressures, see page 31 of ref. 3. Design against fatigue has also been part of the process; see pages 32 and 33 of ref. 3 for early work on this element. Subsequent work has validated the structural margins-of-safety against all anticipated loadings and failure mechanisms, for a representative planned OTEC platform and in a representative expected met-ocean environment including extremes due to storms. Standard offshore and aerospace industry Factors-of-Safety were included.

CWP materials selection

(This section refers to figure 4 of ref. 2 above.) A special “CWP optimizer” computer program was written that can do a minimum-cost design of a pipe having the above architecture, meeting all of the structural requirements, and for any specific material and diameter. The program varies the thicknesses and geometric orientations of the various core and face sheet panels until a cost minimum is reached. For fiber composites, the program also varies the fiber orientation distribution (i.e. the layup) which in turn affects the multi-axial elastic modulus, strength, and fatigue properties. Figure 4 of ref. 2 above shows that fiberglass was the lowest cost solution. Carbon fiber composite was a close second but has some disadvantages shown in the figure. Steel and HDPE did not meet the requirements. Accordingly, fiberglass (with vinyl ester resin for maximum seawater resistance) was selected.

CWP fabrication process strategy

To minimize deployment risk, the CWP is fabricated directly from the OTEC platform (“in-situ fabrication”, see figure 6 of ref. 2 above) vertically down into the water. The fabrication process is Vacuum Assisted Resin Transfer Molding (VARTM) applied in a stepwise manner. Thereby, when the huge pipe is complete, it is already in place, with only the termination and gimbal needing to be installed.

In-situ fabrication allows the face sheet fabric to be continuous down the length of the pipe (see figure 5 of ref. 2 above) except for well-distributed local fabric roll splices where necessitated by the finite fabric roll length. The resin is infused section-by-section. Since in a composite the structural loads are borne by the fibers, the structure behaves much like a one-piece pipe, with none of the detrimental stress concentrations that would be inherent in a composite pipe fabricated in macroscopic sections joined together by bolting, bonding, or both.

Each fabricated section cures completely before the pipe is lowered by one step and the next section is infused and cured. The behavior at the “knitline” between infused sections has been validated, as discussed below.

Process and tooling design

Figure 8 of ref. 2 above describes the tooling design. The molding region where the resin is infused into the fabric contains inner and outer hard shells. Mounted to them are inner and outer silicone rubber soft tools (re-usable vacuum bags). In between the two soft tools is the work-piece, consisting of pre-fabricated core planks that have at that point been bonded together into a complete ring, thereby defining the size and shape of the CWP. The inner and outer face sheets are placed immediately adjacent to the inside and outside of the core, respectively, and get co-bonded to the core during infusion. An image of a core ring is shown below.

Figure 7 of ref. 2 above describes the process. In (a) the soft tools are pulled back against the hard shells by vacuum and the dry fabric and core are advanced one step further into the molding region. In (b) vacuum is pulled on the fabric, evacuating the air and establishing compaction by the soft tools. In (c) the resin is introduced through a single port each for the inner and outer face sheets, at the bottom of the current step of the work-piece. In order to counteract vertical pressure gradients in the liquid resin column of these tall work-pieces, the space between the soft tools and the hard shells is filled with a liquid

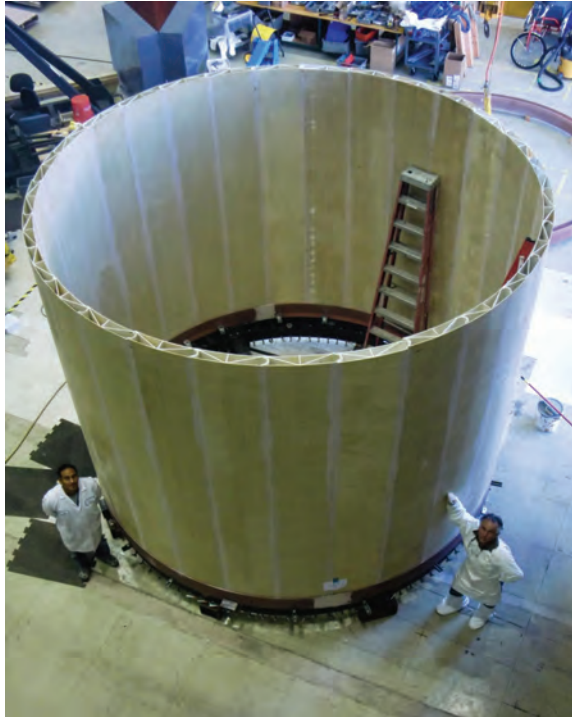

Figure 1. The first assembled core ring for 4 m diameter CWP. Note the size of the core ring compared to the two persons in the photo. Photo taken by the author.

whose density is similar to the resin. In (d) the initial cure is at room temperature. In (e) the soft tools are released from the cured workpiece and in (f) an elevated temperature post-cure confers maximum resistance to long-term seawater immersion.

During infusion, the resin spreads quickly around the circumferences of the inner and outer face sheets by means of a Re-Usable Resin Distribution Line (RURDL) for each face sheet (see Figure 21 of ref. 2 and page 89 of ref. 3). The resin then spreads upwards via the high-permeability Resin Distribution Medium (RDM), then through-thickness in the fabric.

Apparatus design

Figure 9 of ref. 2 shows the design configuration of the large scale apparatus which implements the process/tooling design described above. It is an intermittently-moving vertical production line with materials added at each station. In the top (core assembly) region, the pre-fabricated core planks are assembled into complete rings. As the pipe moves down between steps, the assembled core passes down through the vacuum chamber, inside which are the fabric dispensing mechanisms. They add fabric to the inside and outside surfaces of the core rings, in multiple layers. (Note that the fabric is not cut in between steps; all of the fabric is continuous from section to section in order to make an integral pipe.) The core and fabric then enter the molding region, where the resin is infused (sucked into the fabric) and cured. Cycle time is minimized by having the core assembly operations for one portion of the pipe be concurrent with the resin infusion and cure operations for another portion of the pipe.

Proof-of-Principles apparatus

Before undertaking hardware validation of the process at a large (4m diameter) scale, a 0.5 m/21 inch diameter Proof-of-Principles apparatus containing the key elements of the process was constructed and tested. It showed that the process worked satisfactorily, and also pointed to some improvements to be made on the scaled-up apparatus. See pp. 34-40 of ref. 3 for details.

CWP fabrication process validation to date

Because of funding restrictions at this stage of development, validation was limited to demonstration of three separate critical elements of the process, each of which will now be reviewed. That work was done at a 4 m diameter scale, suitable for a planned 10 MW OTEC Pilot Plant. Analysis has shown that the same process is scalable to the full 10 m diameter CWP's required for 100 MW commercial plants, and to larger diameters if needed.

Core plank design, production, and assembly into core rings

Hollow core planks were designed with triangular cells, and with tongue-and-groove edges for good interlocking when assembled. Figure 11 of ref. 2 shows the plank cross-section, as well as the bonded assembly of the 28 core planks into a complete ring. The diameter of the assembled core ring at multiple sampled locations was within +/- 3 mm over the 4 m diameter, which is far better than required. (The hollow shape stabilizes the planks against warping which in turn leads to excellent overall dimensional control.) See page 59 of ref. 3 for an overall summary of the core validation.

Fabric dispensing mechanisms

Figure 69 of ref. 3 shows solid models of the fabric dispensing mechanisms. The control system maintains constant tension in each fabric roll for all possible motions (see pages 72 and 73 of ref. 3). Figure 14 of ref. 2 shows an overall photo of some of the outer fabric dispensing mechanisms in place on their sub-frame. Figure 15 of ref. 2 shows the outer fabric dispensers in action, forming the overlap splice. Figure 16 of ref. 2 shows data taken on the accuracy of fabric dispensing for repeated runs, multiple overlap splices, and three positions along each splice.

Ideally the edge of the zero degree fibers in one roll should exactly align with the edge of the zero degree fibers in the adjacent roll, forming a 152 mm/6 inch overlap of the 90/+/-45 regions. The green line represents this condition. The red line is what would happen if the edges of the 90/+/-45 regions in the two fabric rolls did not overlap at all, leaving an open gap. It can be seen that all of the data is fairly close to the green line and far away

from the red line, indicating that the outer face sheet fabric dispensing apparatus operated with good accuracy and consistently formed adequate overlaps. Similar results were obtained for the inner face sheet fabric dispensers.

See page 79 of ref. 3 for an overall summary of the fabric dispensing validation.

Molding region

Figure 17 of ref. 2 shows a solid model illustrating the major sub-systems of the molding region, and Figures 19 and 20 of ref. 2 show photos of some of these elements. Figure 18 of ref. 2 provides a visual indication of the size of the molding region for the 4 m diameter pipe.

Figure 23 of ref. 2 outlines the procedure for the three infusion runs made with the molding region. The outer face sheet was infused in one shot, while the inner face sheet was intentionally infused in two shots in order to create a knitline between them. Figure 24 of ref. 2 shows that the actual infusion process requires only a two-person crew, because of the highly mechanized nature of the apparatus. The catalyzed resin supply system (see page 101 of ref. 3) keeps the volume of catalyzed resin not yet infused very small, and accordingly about 455 kg of resin was infused in the three shots with no exotherm problems. The fill time agreed with the specialized VARTM flow model used to design the process (and to quantitatively evaluate scale-up) to within about 20 %.

Good control of the end position of the flow front for each shot was obtained by means of breaks in the active portion of the Resin Distribution Medium (see page 121 of ref. 3).

Figure 26 of ref. 2 shows the 4 m workpiece being removed from the molding region.

Figure 25 of ref. 2 shows data on fill at various positions, proving that the RURDL worked as planned. Figure 27 of ref. 2 demonstrates the successful operation of the RURDL mechanism (it leaves barely a trace on the workpiece) and the related mechanism that causes the Resin Inlet Line to break off cleanly at the CWP surface after cure.

Finally, Figure 28 of ref. 2 provides the initial validation that the stepwise VARTM process works as planned. On the cut cross-section, the knitline is indistinguishable from the base laminate. Subsequent work has established this same result at much higher magnification.

See page 148 of ref. 3 for an overall summary of the Stepwise Infusion Molding validation.

Summary and future plans

The work reported in references 2 and 3 has successfully validated the three most critical elements of the Advanced Composite Cold Water Pipe fabrication process, namely:

- Core plank production and assembly into core rings
- Fabric architecture and fabric dispensing
- Stepwise infusion molding

Figure 29 of ref. 2 summarizes the future plans for utilization of this same design and fabrication process in a future OTEC pilot plant and commercial-sized plants.

The work on validation of the Advanced Composite Cold Water Pipe is continuing.

Dr. Alan Miller received his BS, MS, and PhD degrees in Mechanical Engineering and Materials Science from Cornell and Stanford. He was a Research Professor at Stanford for 15 years before joining Lockheed in 1990. He holds 15 issued patents, and has authored or co-authored over 100 published journal/conference papers and book chapters. Currently, he is a Senior Composites Engineer with Specialized Bicycles in Morgan Hill, CA. He may be contacted at alanmiller21@gmail.com.

Production of Fresh Water using Renewable Ocean Thermal Energy

*Dr. C. B. Panchal, Consultant,
USA*

Introduction

Much has been said and written about the growing crisis of the world's fresh water supply (e.g., recent news WP 2012; Muller 2013; Caribbean 360, 2013; MSNBC 2014). Water is mankind's most precious resource – there is no substitute for clean water. However, a focused, sustained, long-term program for meeting the demands of water and energy on an individual national and global scale is lacking. This vital resource is facing critical challenges from the: a) increasing population in regions with a scarcity of fresh water; b) increasing demand for fresh water for energy production and the process industry; and c) shifting global weather patterns. A recent report *The Water-Energy Nexus: Challenges and Opportunities* (US Department of Energy, June 2014) describes the interdependency of energy and water and global challenges in terms of resource scarcity, variability, and uncertainty. Increasing demands in one sector can seriously impact other sectors with major impacts on economic sustainability.

Ocean thermal energy is an option that can make significant contributions to a solution for a sustained supply of fresh potable water. The world's oceans are the largest collectors and storage of solar energy with 24 hours a day, 365 days a year, availability on a sustained basis. The unique feature of ocean thermal energy to produce both power and fresh water has the potential of significantly improving the techno-economic viability of regions facing a scarcity of fresh water and high energy costs. There are different thermocline-driven desalination systems (TDDS) for fresh water production. The techno-economic viability of these options can be further improved for land-based plants, if the ocean thermal plant can be integrated

with local utility power plants utilizing waste heat normally rejected to warm seawater.

Water Resources in 21st Century

The World Health Organization and the United Nations estimate that more than 800 million of the world's 7.1 billion people lack clean, healthy potable water. It is not necessarily the problem of poor countries, industrialized countries are also facing a scarcity of fresh water. The global scarcity of fresh water can be based on economic and/or simply physical reasons. Major regions with current and approaching water scarcity are major parts of Africa, Indian subcontinent, west part of south America, south west of North America and middle-east Countries (Scott, 2013). Many Island States are currently facing a critical shortage of fresh water that would get worse with the potential impacts of the climate change.

Fresh water is a vital resource for human life that is facing the following three major critical challenges:

- Increasing populations along with an improved standard of living;
- Increasing demands of fresh water for energy production and manufacturing industries; and
- Shifting global weather patterns and climate changes imposing scarcity of good quality water where needed.

Typical water usage in an industrialized nation is distributed as follows (Gasper, 2005):

- For food (indirect): 1900 liters/person/day;
- For electricity (indirect): 1700 liters/person/day; and
- Direct use: 400 liters/person/day.

As can be seen, water used for production and processing of food and energy production is relatively large. With an improved standard of living in developing nations, this water consumption pattern will shift to reflect the numbers above and in turn further strain the supply of fresh water.

Energy-Water Nexus

Energy and water are inextricably linked; water production, treatment and distribution need energy, and energy production needs water. Below are some examples of typical water consumption for energy production.

- Between 2 and 8 liters of water consumption/kWh power generation depending on fuel;
- 8 million liters to drill single horizontal well in the “fracking” process;
- 3 liter/liter of ethanol, not including irrigation water;
- 132 liters/kg hydrogen via high temperature electrolysis (1 kg is equivalent to 1 gallon of gasoline) and
- 19 liters/kg hydrogen via steam methane reforming (SMR)

This Energy-Water-Nexus needs to be addressed for sustainable energy and water supply for all nations, specifically regions with a present scarcity of fresh water.

Water Supply

The current water supply is as follows, with an increasing energy consumption for each supply method. The relative energy consumption for these methods is presented in Figure 1 (Gasper 2005).

- Natural water – treatment and distribution
- Impaired fresh water – purification, treatment and distribution
- Brackish water – desalination, treatment and distribution
- Seawater – desalination, treatment and distribution

Power requirements for current and future water supply

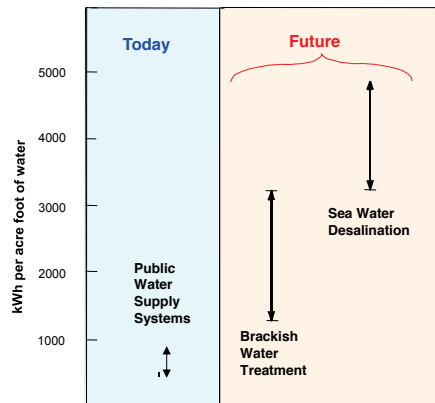

Figure 1. Energy Consumption in Present and Future Water Supply.

Global production of desalinated water is 40 million m³/day of which nearly ½ are multi-stage thermal or multi-effect evaporation (mostly in Middle East counties) and the remainder are reverse osmosis (RO) membrane systems for brackish and seawater RO (SWRO). Thermal desalination plants in general are co-located with utility plants to utilize low-pressure steam as heat sources. There is an increasing trend of using waste heat from the industrial processes for thermal desalination. The RO processes with improved efficiency are being increasingly used for desalination due to their modular design and improved efficiency.

Ocean Thermal Desalination (OTD)

The unique characteristic of ocean thermal energy is a co-production of power and desalinated water. Below, four potential technologies for water production using ocean thermal energy are described and their relative merits identified.

Option A – Open Cycle

Co-production of power and fresh water using an open cycle OTEC system equipped with a surface condenser and direct-contact condenser. The relative sizes of direct-contact and surface condensers can be designed to match local power and fresh water demands. The open cycle has been extensively studied as represented by the Westinghouse Design (1980) and demonstrated by 210-kW pilot plant in Hawaii (Vega 1995; Panchal, Vega and Bell, 1997; Zagrando et al., 1990), as shown in Figure 2. The techno-economic viability of the open cycle is such that this option may not be feasible in the near future.



Figure 2. 210 kW Open-Cycle Pilot Plant with Surface Condenser for Water Production. Photo by the author.

Options B – Ocean Thermal Desalination

In this desalination option warm surface seawater is flash evaporated in one or two-stage flash evaporators. The resulting low-pressure steam is condensed in a surface condenser cooled by deep-ocean cold seawater, as shown in Figure 3. The

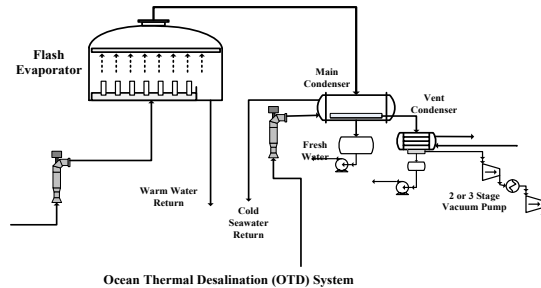

Figure 3. Ocean Thermal Desalination Process.

The parasitic power required for seawater pumping and the vacuum system can be provided using a closed-cycle OTEC system, by diesel/gas powered engines for floating plants, and commercial power for land-based plants. In the absence of a low-pressure turbine for power generation in the open cycle, larger temperature differences are available for desalination that would reduce the size of heat exchangers and seawater flow rates. Parasitic power consists of seawater pumping and vacuum system which is of the order of 2.4 kWh/m^3 of water production as compared to 3.6 kWh/m^3 required for an energy efficient RO system.

Option C – Hybrid-OTEC system

This is an integrated ammonia-Rankine cycle and desalination process for the simultaneous production of power and fresh water as shown in Figure 4 and model in Figure 5 (Panchal and Bell, 1987). In this system, warm seawater is

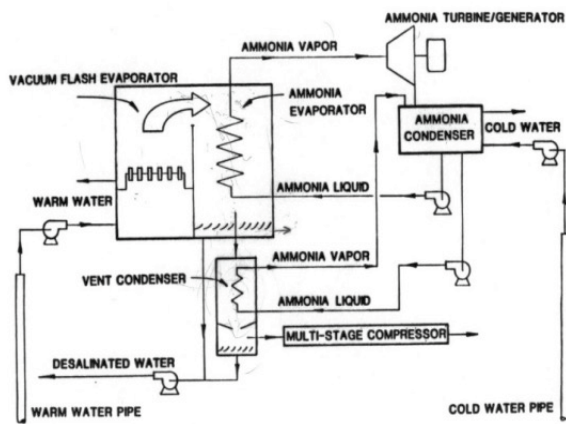

Figure 4. Hybrid OTEC System.

flash evaporated like in the open cycle and the resulting low-pressure steam is condensed by vaporizing ammonia. Ammonia vapor runs the turbine and the exhaust ammonia vapor is condensed against deep-ocean cold water, like in the closed cycle. Biofouling is eliminated in the hybrid cycle and brazed aluminum plate-fin heat exchanger can be used as steam condenser/ammonia evaporator. The typical rate of fresh water production is about 3.0 million liters per MWe net power generation. However, the relative production of power and fresh water can be optimized based on local demand and the market value of electric power vs water.

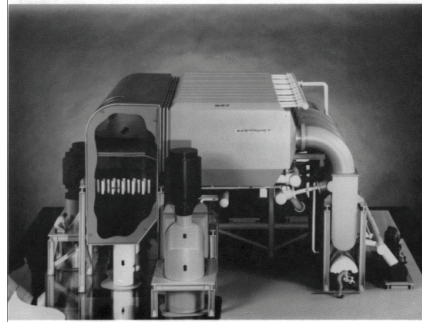

Figure 5. Hybrid OTEC Model System.

Option D – RO-Based OTEC Desalination

This option for OTEC water production is basically operating the RO system using OTEC power as shown in Figure 6. Typically large-scale RO systems consume 3.5 to 5.0 kWh/m³ water production with high-efficiency pressure recovery. So, 1 MWe power would produce between 4.8 and 6.8 million liters per day with zero net power to feed to the grid. The OTEC-RO system has three major advantages over conventional shore-based RO systems. If deep-ocean cold seawater is used for desalination then biofouling of the membrane would be minimal and would reduce chemical treatments, leading to a longer membrane life. Additionally, desalinated water may have premium value as bottled water. Furthermore, the concentrated brine from the RO system can be mixed with returning cold or mixed waters from the OTEC plant, which would minimize the environmental impacts of discharging concentrated brine to coastal water as is commercially practiced.

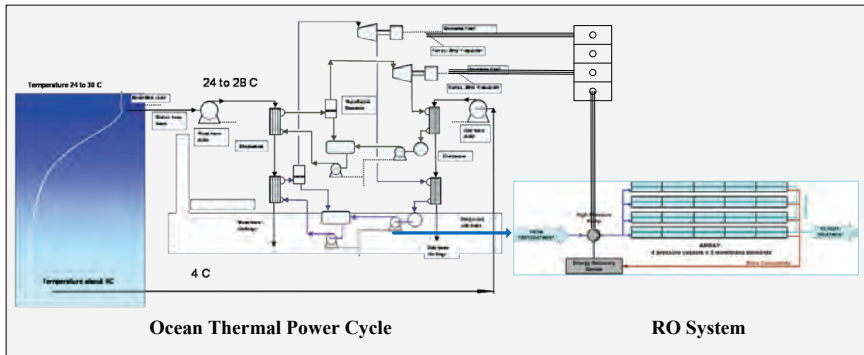

Figure 6. OTEC-RO System for Water Production.

Technology Readiness Level (TRL)

Component and subsystem level performance in these four options have been validated by testing and prediction methods. Validated design methods have been developed based on performance data obtained at the Natural Energy Laboratory of Hawaii Authority (NELHA). Furthermore, design studies have been carried for a 100 MWe floating open-cycle OTEC plant (Wesinghouse, 1980) and 10 MWe hybrid-cycle land-based plant (Panchal and Bell, 1987). Therefore, the technology readiness level (TRL) can be categorized at TRL-7, which is defined by “Integrated Pilot Systems Demonstrated – System process prototype demonstration in an operational environment”.

Economics of Seawater Desalination

The economic merits of OTEC-water production should be based on seawater RO (SWRO) in terms of capital expenses (CAPEX), energy consumption, carbon credit, environment impacts and O&M costs. The cost of water produced by the RO system is highly dependent on the local cost of electricity (COE), as presented in Table 1; it increases from \$1.42/m³ at COE of \$0.15/kWh to \$2.14/m³ at \$0.35/kWh. Design studies show that small scale OTD can be competitive to SWRO powered by diesel engines (Rabas, Panchal and Genens, 1990). Furthermore, floating OTD can be competitive and overcome environment impacts of land-based

SWRO powered by fossil utility or nuclear plants. However, focused design studies are required to evaluate the techno-economic viability of OTEC water production using one of the OTD technologies. Economic merits can be significantly improved if land-based OTD is integrated with waste heat sources from utility and industrial plants.

Table 1. Cost Analysis of Seawater RO Process. Production capacity: 10,000 m³/day. Costs in USD.

Type	Seawater RO		
Total installed costs (TIC)	14,845,100	14,845,100	14,845,100
Leveled costs, depreciation over 10 years	1,484,510	1,484,510	1,484,510
Electric power, kW	1,500	1,500	1,500
Electric rate, USD/kWh	0.15	0.25	0.35
Energy costs	1,782,000	2,970,000	4,158,000
O&M and membrane replacements costs	1,406,500	1,406,500	1,406,500
Total annual cost	4,673,010	5,861,010	7,049,010
Cost of water, USD/m ³	1.42	1.78	2.14
USD/kgal	5.36	6.73	8.09

Path Forward

The potential of renewable ocean thermal energy for the production of fresh water is enormous. In order to capitalize on this natural source and meet the basic human needs of fresh water, a well-coordinated effort is required among different nations and organizations.

The path forward with a focus on the water needs of Africa and Small Island Developing States (SIDS) is as follows:

- Feasibility design studies to evaluate techno-economic viability of OTD in African Countries;
- Development of strategic alliances within Africa and with private as well as government organizations from other countries;
- Strategic alliances with SIDS that are facing severe scarcity of sustained water supply; and

- ♦ Approaching Non-Government Organizations (NGOs) and the United Nations (UN) for initial funding for feasibility studies and developing centers for water supply in African and SIDS countries.

C. B. Panchal is a chemical engineer who works as a consultant. Dr. Panchal does work for OTE plc. among other companies. His areas of expertise include mitigation of fouling of heat transfer equipment (petroleum fouling and seawater fouling), energy efficiency (reactive distillation, heat integration, waste heat recovery and utilization), process intensification (reactive distillation, enhanced performance of heat transfer equipment), and OTEC (system design & integration, OTEC-optimized heat exchangers, economic analysis).

References

- Caribbean 360, “Climate Change Threatens Caribbean Water Supply”, September 11, 2013.
- CNBC, J. Cox, “Matt Damon urges Help from World’s Rich on Water Crisis at the Davos Meeting”, www.cnbc.com, January 22, 2014.
- Gasper J, “Energy-Water Nexus and the Process Industry”, AIChE Presentation, April 2005.
- Muller Philip, “Pacific Islands’ Deadly Threat from Climate Change”, *Washington Post*, May 30, 2013.
- Panchal, C. B., and K. J. Bell, “Simultaneous Production of Desalinated Water and Power Using a Hybrid-Cycle OTEC Plant”, *Journal of Solar Energy Engineering*, Vol. 109, pp. 156, May 1987.
- Panchal, C. B., L. Vega, and K. J. Bell, “Plate-Fin Condenser for Condensation of Low Pressure Steam in the Presence of Noncondensable Gases”, *Compact Heat Exchangers for the Process Industry*, Begell House Publishing, New York, NY 1997.
- Scott A, “Running Dry”, *Chemical & Engineering News*, July 22, 2013.
- Rabas, T. J., C. B. Panchal, and L. Genes, “Design and Cost of Near-Term OTEC Plants for the Production of Desalinated Water and Power”, *ASME Publication – Solar Energy in the 1990’s*, SED-Vol. 10, pp. 89, 1990.
- US Department of Energy, “The Water-Energy Nexus: Challenges and Opportunities,” DOE Report, June 2014.
- Vega L, “The 210 kW Apparatus: Status Report”, Oceans’95 Conference, San Diego, CA, USA 1995.
- Westinghouse Electric Corporation, “A Study to Determine the Commercialization Potential of Open-Cycle OTEC Water Plants”, Department of Commerce Report, Contract No. MA-79-SAC 00063, July 1980.
- WP, The Washington Post, “Report: Water Shortages Increasingly will Offer New weapons for States, Terror Groups”, by Karen DeYoung, Published March 22, 2012.
- Zangrando, F., D. Bharathan, H. Link, and C. B. Panchal, “Seawater Test Results of Open-Cycle Ocean Thermal Energy Conversion Components”, *Journal of Heat Transfer Engineering*, Vol. 11, No. 4, pp. 44, 1990.

OTEC Technology for Aiding Women in Developing Countries: An Investigation of Women's Health-Related Quality of Life in Rural Areas of Iran near the Coast of Gulf of Oman

*Zabira Yadali Jamaluei,
Department of Sociology and Social Planning, Shiraz University,
Shiraz, Fars, Iran*

Abstract

The focus of this article is to examine the impact of OTEC technology on the health-related quality of women's lives for aiding women in developing countries. Especially, this study deals with the humanitarian issues of how the women in rural areas of Iran, in particular, in the coast of Gulf of Oman can benefit from clean fresh water and electricity produced from OTEC technology. The author intends to raise awareness of OTEC technology in Iran for easing the lives of women in rural areas particularly near the coast of and the Gulf of Oman.

Population-based studies pertinent to health-related quality of life in people living in the areas near the Coast of Persian Gulf and Gulf of Oman indicate that women, as compared to men, are more likely to perceive worse health-related quality of life, in terms of physical and mental well-being.

Keywords: mental well-being; marital satisfaction; women; OTEC technology; quality of life; urban areas.

Introduction

This study deals with the humanitarian issues of how the women in rural areas of Iran, in particular, in the coast of the Gulf of Oman can benefit from water and electricity from Ocean Thermal Energy Conversion (OTEC) facilities.

OTEC is a clean technology for extracting energy from the sea water. The sea water that goes in an OTEC facility is used not only to produce electricity, but also it becomes desalinated. After desalination, therefore, thousands of cubic meters of clean fresh water can be produced every day through an OTEC facility. While the Persian Gulf is too shallow for providing suitable conditions for OTEC, the Gulf of Oman seems to have the appropriate hydrographic conditions (Reynolds 1993). Fresh water generated by OTEC there, can be distributed in a wider area, including within the Persian Gulf provinces of Iran.

From western Africa to the east, some of the countries suitable for OTEC include Democratic Republic of Sao Tome and Principe, Gabon, Republic of the Congo, Democratic Republic of the Congo, Uganda, Kenya, Somalia, Maldives, Indonesia, Kiribati, Baker Island, Ecuador, Colombia, and Brazil. However, some industrialized countries, which include Japan, USA, and India, have experiences from using OTEC and similar technologies for some time now to produce fresh water and electricity in a clean manner. This fact indicates that although these three countries, in principle, will not benefit the most from the use of OTEC (as compared to the above-mentioned 14 countries), this technology can efficiently be adopted to produce electricity and fresh water, even in countries where the condition for using OTEC technology is not immediately adoptable. All these facts indicate that OTEC can potentially be used to produce clean fresh water and electricity for the humanitarian cause of aiding the women in rural areas of Iran, in particular, near the coast of Gulf of Oman (Fig. 1). This study aims to raise awareness of the humanitarian issues of how the health-related quality of women's lives in these areas of Iran can benefit from the clean fresh water and electricity from adopting OTEC facilities.

Problems in Supplying Clean Fresh Water to People near the Coastal Boundaries of Persian Gulf and Gulf of Oman in Southern Iran

Iran has 2410 km of coastal boundaries along the Persian Gulf, Gulf of Oman and Caspian Sea. The littoral states of the Persian Gulf are Bahrain, Iran, Iraq, Kuwait, Oman, Qatar, Saudi Arabia, and the UAE. The coastline is shown in figure 1.

To the south, the coast line is flat while the cost on the Iranian side is mountainous. In the northern portion of the Persian Gulf, there is an evaporation rate higher than the supply of fresh water into the Gulf. In addition, irrigation methods and overuse in Iraq are believed to be likely responsible for the slowing rate of flow of fresh water into the Persian Gulf (Zumerchik and Danver, 2009).

Much of Iran's territory suffers from desertification and/or deforestation. Industrial and urban wastewater runoff has contaminated rivers and coastal waters and threatened drinking water supplies. Wetlands and bodies of freshwater are increasingly being destroyed as industry and agriculture expand, and oil and chemical spills have harmed aquatic life in the Persian



Figure 1. Map of the Strait of Hormuz and adjacent area, and a satellite image and a computer generated image of the ocean floor of an enlarged area (courtesy of Google). As can be seen, the Gulf of Oman is deeper than the Persian Gulf.

Gulf and the Caspian Sea.

Although a Department of Environment has existed since 1971, Iran has not developed a policy of sustainable development because short-term economic goals, particularly support of the oil and gas industries, have taken precedence. Most importantly, the Persian Gulf region has scarce fresh water sources and depends on desalination plants that purify uncontaminated seawater into drinking water. These plants are often very expensive to run (Aminmansour, 2013; Patin, 1999).

Along the frontier between Iran and Afghanistan, there are several marshy lakes which expand and contract according to the season of the year. The largest of these, the Seestan (Hamun-Sabari), in the north of the Sistan and Baluchestan Province, is alive with wild fowl (Urban and Rural Development Network, 2013). Real fresh water lakes are exceedingly rare in Iran. There probably are no more than 10 lakes in the whole country, most of them brackish and small in size. The largest are: Lake Urmia (area: 3,900-6,000 sq. km. depending on season) in Western Azerbaijan, Namak (1,806 sq. km.) in the Central province, Bakhtegan (750 sq. km.) in Fars province, Tasht (442 sq. km.) in Fars province, Moharloo (208 sq. km.) in Fars province, Howz Soltan (106.5 sq. km.) in Central province (Urban and Rural Development Network, 2013).

Bushehr Province is one of the 31 provinces of Iran. It is in the south of the country, with a long coastline onto the Persian Gulf. Its center is Bandar-e-Bushehr, the provincial capital. The province has nine counties: Asaluyeh, Bushehr, Dashtestan, Dashti, Dayyer, Deylam, Jam, Kangan, Ganaveh and Tangestan (Bushehr Cultural Heritage Organization, 2013). In some coastal areas of the Persian Gulf in Bushehr Province, consumption of contaminated drinking water is one of the issues, which is threatening to health. Most importantly, the amount of fluoride in groundwater, dates, and wheat in Bushehr Province is worrying because of the estimated exposure dose in the population of Bushehr, Iran. The maximum estimated fluoride intake (from dates and drinking water) for children and adults in Bushehr province in southern Iran are 3.4 and 1.6 times higher, respectively, than the minimum risk level determined by the Agency for Toxic Substances and Disease Registry (Battaleb-Looie et al., 2012). Moreover, in some cases, the microbial quality of the consumed drinking water is lower than the available

standards (Ranjbar Vakilabadi et al., 2012). To sum up, the need of water supply in the cities and villages are the most important concerns in Bushehr Province. Overall, the consumption of contaminated drinking water has an adverse effect on women's mental and physical health (including birth defects, miscarriage, and mental well-being) and the overall quality of women's lives in Bushehr Province.

Sistan and Baluchestan Province is in the southeast of the country, bordering Pakistan and Afghanistan and its capital is Zahedan.

The minimum and maximum concentrations of cobalt in these areas have been around 0.172 and 0.204 ppm, respectively, which are significantly higher than the standard limit (0.05 ppm). In some areas of this region, anomaly centers with very high water pollution have been observed due to ground water pollution by industrial, agricultural and animal husbandry activities, and geology and geochemistry of the Sistan and Baluchestan Province.

Furthermore, although the source of drinking water in Sistan and Baluchestan Province has shown weak association with transmission of cholera (Izadi et al., 2006), the impact of drinking water sources and their pollution on several cholera outbreaks in this province may not be insignificant. Moreover, mercury contamination in drinking water is a potential risk on human health and environment. Most importantly, the study of mercury concentration levels in Zahedan aquifer in Sistan and Baluchestan Province, which has been published in the *Oriental Journal of Chemistry* by Atashi et al. (2010), indicates that the minimum and maximum concentration of mercury in this aquifer is 0.39 and 2.32 ppb, whereas the standard limit of mercury in water is 1 ppb. This means that due to ground water pollution by industrial, geological, geochemistry and other pollution factors, high concentrations of mercury makes the drinking of ground waters in this area very dangerous (Atashi et al., 2010). It has long been recommended that an expert group of economists, economical geologists, geochemists and hydrogeologists must study the qualitative and quantitative effects of geology on the elements, and especially, existence of heavy metals in ground water in Sistan and Baluchestan Province. However, such effort has never been initiated over the past several decades. Thus, the risks of using drinking water to mental and physical health in Sistan and

Baluchestan Province cannot be overemphasized. This includes the adverse effects on women's mental and physical health (i.e., miscarriage and mental well-being) and a significantly lower quality of women's lives in provinces, where gender issues have a lot to do with the acquisition of fresh water and needing electricity for performing household duties, as for example, acquisition of fresh water for cooking is typically a woman's job in rural parts of Sistan and Baluchestan Province.

Iran is situated in an arid to semi-arid zone and the average mean annual rainfall for the entire country is about 250 mm per year. Therefore, the problem of water shortage for drinking and irrigation has existed for many years. Hormozgan Province, which is located in the northern part of Persian Gulf coast, is one of the most arid parts of Iran. In this area, the average annual rainfall is about 160 mm. In Hormozgan, most of the rivers are ephemeral, because they only have water during the wet seasons. Due to the surface water limitation with respect to quantity and also quality, most of water demands for irrigation and drinking are met from ground water resources (Hossainipour Kooveei et al., 2013)

The groundwater quality in the area is reduced in value by this mineral dissolution from the diapirs and characterized by high sodium absorption ratio (SAR) and dominant hardness that limit the suitability for agricultural use.

There is a growing concern that the natural cycling rates of many metals are being disturbed by anthropogenic activities, especially the release from industrial, domestic and urban effluents of increasing amounts of Lead, Zinc, Cadmium, and Copper (Shiber, 1980).

Health-Related Quality of Life in Women's Population Living in Areas of Iran near the Coast of Persian Gulf and Gulf of Oman

A population-based study conducted by Aghamolaei et al. (2010) in Hormozgan Province showed that the overall health related quality of life and relative differences between men and women and also between different age groups.

However, differences in sociodemographic factors such as age group, education, living status, smoking status and suffering from chronic diseases may partly explain the worse score registered by women on the physical aspect of health-related quality of life. The results of this analysis show that regardless of other variables, just gender differences could significantly increase the risk of lower score of physical aspect of health-related quality of life. Although authors indicate that gender differences could not change the mental aspect of health-related quality of life, this issue needs to be investigated in further detail.

A large number of reports have asserted the differences in the quality of life between men and women in developing countries. The results of several research studies conducted on the health-related (physical and mental well-being) quality of women's lives in areas of Iran near the Coast of Persian Gulf and Gulf of Oman should be considered and applied by health policy makers and health program planners where they must be considering women as a high-risk group, who are more vulnerable than men to parameters like basic needs of life, health care, and environmental factors (e.g. social support, chronic diseases), which more significantly impact the health-related quality of life in women as compared to quality of life in the male population. Access to basic needs of life (such as clean fresh water, electricity, and providing other elements essential to a better personal hygiene) is one of the factors that could increase the health-related quality of life more significantly in female population than in male population.

Potential long-term impacts of OTEC technology through simultaneously providing clean fresh water and electricity on improving the health-related (physical, social and mental) quality of women's lives in rural areas of Iran, particularly near the Gulf of Oman, is one of the environmental factors that has yet to be investigated in detail. It should be noted that the mental and physical well-being of women has been correlated to marital satisfaction in women living in modern and traditional cities and in rural areas of Iran (Yadali Jamaloei and Iman, 2013; Yadali Jamaloei et al., 2012, 2013).

Potential Impacts of clean water on the Quality of Women's Lives in Rural Areas of Iran

The benefits of clean water and having plenty of safe water to drink are well known. Access to safe, clean water opens up a world of possibilities for community development. Sanitation and hygiene, working together with a source of clean water create lasting community health and sustained human growth and development. From the early years of life, throughout childhood and into adulthood, water is the common beneficial factor determining the quality of life and the possibilities of the future. The benefits of clean water influence the daily lives of children and adults, and impact the quality of life in a community for generations to come. Dirty water is the world's biggest health risk, and continues to threaten both quality of life and public health (Natural Resources Defense Council, 2013).

Cutler and Miller (2005) have demonstrated the strikingly large and cost-beneficial role of clean water technologies. They have examined the era of the most rapid documented decline in mortality in American history, and clean water appears to have played as large a role as any force responsible for this rapid progress. Although findings from the early twentieth century in the United States cannot be compared directly to the current circumstances of developing countries, the results give some indication of the tremendous health and economic gains achievable through clean water technologies. Worldwide, roughly 1.1 billion people lack access to safe water and 1.7 million people die every year from diarrheal diseases. Applying results from their analysis, and assuming that only 1 % of the annual deaths from diarrheal diseases could be prevented by water disinfection, Cutler and Miller (2005) estimate the corresponding social rate of return would be about \$160 billion annually (Water Quality and Health Council, 2013).

The struggle for access to clean drinking water is indicative of how water scarcity leads to the stalling of human progress. It is an issue that touches all aspects of development including health, agricultural productivity, education and opportunities of women and children, stability and peace, as well as economic productivity.

In some parts of many developing countries, available clean water for women and children translates to greater potential for education, and thus prosperity, power, literacy, hygiene, security, and equality.

In some parts of developing countries, particularly in rural areas, women and men's divergent social positions lead to differences in water responsibilities, rights, and access, and so women are disproportionately burdened by scarcity of clean drinking water. In some developing countries, women are seen as the collectors and managers, guardians of water, especially within the domestic sphere that includes household chores, cooking, washing, and child rearing. According to Roy and Crow (2004), because of these traditional gender labor roles, women are forced to spend a significant amount of time collecting water, which translates to a decrease in the amount of time available for education.

Furthermore, for women in some developing countries, their daily role in clean water retrieval often means an extensive labor work during the day. This has health consequences such as permanent skeletal damage, which translates to a physical strain that contributes to increased stress, increased time spent in health recovery, and decreased ability to not only physically attend educational facilities, but also mentally absorb education due to the effect of stress on decision-making and memory skills. Also, Roy and Crow (2004) argue that, in terms of health concerns, access to safe and clean drinking water leads to greater protection from water-borne illnesses which increases women's capabilities to attend school.

Summary and Conclusion

The focus of this article is to examine the impacts OTEC technology can have on the health-related quality of lives for aiding women in developing countries. Especially, this study deals with the humanitarian issues of how the women in rural areas of Iran, in particular, in the coast of Persian Gulf and Gulf of Oman can benefit from clean fresh water and electricity produced from OTEC technology.

A population-based study pertinent to health-related quality of life in people living in Hormozgan Province indicate that women, as compared to men, are more likely to perceive worse health-related quality of life,

especially in terms of physical component. The results of several research studies conducted on the health-related (physical and mental well-being) quality of women's lives in the areas of Iran near the Coast of Persian Gulf and Gulf of Oman should be considered and applied by health policy makers and health program planners where they must be considering women as a high-risk group more vulnerable than men to parameters like basic needs of life, health care, and environmental factors (e.g. social support, chronic diseases), which more significantly impact the health-related quality of life in women as compared to quality of life in the male population. Due to religious and political problems in Iran especially discriminations against women in rural areas access to basic needs of life is a tremendous dilemma. After Islamic revolution in Iran in 1979, rigid religious rules lead to crucial catastrophes in women's rights particularly in deprived regions. Improved access to clean fresh water through using OTEC technology near the coast of the Gulf of Oman can potentially influence women's allocation of time, level of education, their potential for higher wages associated with recognized and gainful employment, greater protection from water-born illnesses, reduction in possible physical strain, decreased stress, decreased time spent in health recovery, and increased ability to not only physically attend educational facilities, but also mentally absorb education due to the effect of reduction of stress on decision-making and memory skills. It is recommended to conduct a feasibility study on OTEC in the Gulf of Oman.

Zahra Yadali was previously at the Department of Sociology and Social Planning, Shiraz University, Shiraz, Fars, Iran She now works for Vekalat Magazine in Tehran, Iran, and is a member of the Editorial Board and the Director of Public Relations.

References

- Aghamolaei, T., Tavafian, S.S., Zare, S., 2010. Health Related Quality of Life in Elderly People Living in Bandar Abbas, Iran: A Population-Based Study. *Acta Medica Iranica* (Tehran University of Medical Sciences), 48(3), pp. 185-191.
- Aminmansour, M., Pollution in Persian Gulf. Pars Times.
http://www.parstimes.com/environment/pg_pollution.html (Retrieved 3 May 2013).
- Atashi, H., Sahebi-Shahemabadi, M., Mansoorkiai, R., Akbari Spaili, F., 2009. Cobalt in Zahedan Drinking Water. *Journal of Applied Sciences Research*, 5(12), pp. 2203-2207.
- Battaleb-Looie, S., Moore, F., Malde, M.K., Jacks, G., 2012. Fluoride in Groundwater, Dates and Wheat: Estimated Exposure Dose in the Population of Bushehr, Iran. *Journal of Food Composition and Analysis*, 2012(10).
- Cutler, D., Miller, G., 2005. The Role of Public Health Improvements, in: *Health Advances: The Twentieth-Century United States*. Demography, 42 (1), pp. 1-22.
- Ghaneian, M.T., Khademi Bafrooei, H., Zirakrad, A., 2012. The Effect of Seawater Quality on Reverse Osmosis Operational Problems in Hormozgan Province, Iran. 2012 IWA World Water Congress Exhibition.
- Hossainipour Kooveei, H., Gieske, A.S.M., Ghayomian, J. Groundwater Quality Analysis of the Sarchahan Plain Aquifer Using GIS. *Ground Water Assessment*:
<http://www.gisdevelopment.net/application/nrm/water/ground/mi05220.htm>
- Izadi, S., Shakeri, H., Roham, P., Sheikhzadeh, K., 2006. Cholera Outbreak in Southeast of Iran: Routes of Transmission in the Situation of Good Primary Health Care Services and Poor Individual Hygienic Practices. *Japanese Journal of Infectious Diseases*, 59, pp. 174-178.
- Nejatkhah Manavi, P., 2013. Heavy Metals in Water, Sediment and Macroenthos in the Intertidal Zone of Hormozgan Province, Iran. *Journal of Marine Science*, 3(2), pp. 39-47.
- Patin, S. A., 1999. *Environmental impact of the offshore oil and gas industry*. Ecomonitor Publishing, New York.
- Ranjbar Vakilabadi, D., Dobaradaran, S., Kazemi Vakilabady, T., Tahmasbi, R., Ravanipur, M., Farahmandnia, M., 2012. Bacterial Quality of Drinking Water in Bushehr Intercity Buses in 2010. *JFUMS*, 2(3), pp. 187-192.
- Reynolds, R. M., 1993. Physical Oceanography of the Persian Gulf, Strait of Hormuz, and the Gulf of Oman – Results from the Mt. Mitchell Expedition. *Marine Pollution Bulletin*, 27, pp. 35-59.

Roy, J., Crow, B., 2004. Gender Relations and Access to Water: What We Want to Know About Social Relations and Women's Time Allocation. *Working Papers*, 2004(5), Center for Global, International and Regional Studies, University of California, Santa Cruz.

Shiber, J. G., 1980. Trace Metals with Seasonal Considerations in Coastal Algae and Mollusks from Beirut, Lebanon. *Hydrobiologia*, 69, pp. 147-162.

Yadali Jamaloei, Z., Iman, M.T., 2013. Mental Well-Being and Marital Satisfaction. *Journal of Applied Sociology*, 48(4), pp. 1-5.

Yadali Jamaloei, Z., Iman, M.T., Zohri, A., 2013. An Investigation of the Relationships between Social Capital and Marital Satisfaction. *Journal of Social Sciences: Azad University of Shushtar* (in Persian).

Yadali Jamaloei, Z., Iman, M.T., Lahsaeizaeh, A., 2012. Religious Orientation and Marital Satisfaction. *Journal of Iranian Social Studies*.

Zumerchik, J., Danver, S.L., 2009. *Seas and Waterways of the World: An Encyclopedia of History, Uses, and Issues*. ABC-CLIO.

Web resources with no author

A Layman's Guide to Clean Water: The Benefits of Clean Water Influence the Daily Lives of Children and Adults, and Impact the Quality of Life in a Community for Generations to Come. <http://www.clean-water-for-laymen.com/benefits-of-clean-water.html> (4 May 2013).

Coping With Water Scarcity: Challenge of the 21st Century. <http://www.fao.org/nr/water/docs/escarcity.pdf> (18 March 2013).

Natural Resources Defense Council: <http://www.nrdc.org/water> (4 May 2013).

Official Website of Hormozgan Governorship: <http://www.hormozgan.ir> (3 May 2013).

Official Website of Sistan and Baluchestan Governorship: <http://www.sbportal.ir/default.htm>. (3 May 2013)

OTEC Africa: <http://www.otecafrika.org/Conference/Default.aspx> (3 May 2013).

Urban and Rural Development Network: <http://urdn.tu-berlin.de/activities/country-profiles/iran.php> (3 May 2013).

Water Quality and Health Council: Chlorination, Clean Water and the Public Health Progress that Changed America (20th Century Lessons-Learned for 21st Century Developing Nations) <http://www.waterandhealth.org/newsletter/chlorination.html> (4 May 2013).

Preventing environmental impacts of OTEC

*Dr. Linus Hammar,
Chalmers University of Technology, Sweden*

Importance of environmental issues

The OTEC technology has enormous potential of delivering electric power and fresh water for consumption and irrigation. Nevertheless, there is a need of careful implementation with respect to the marine environment.

Over the last few centuries, human exploitation of the seas has been devastating as a cause of ocean industrialization (Smith 2000). With ever-increasing technological development and low regulation we have effectively changed many marine ecosystems and there is no part of the oceans that is unaffected by our presence (Halpern et al. 2008). This means that many of the marine ecosystems, both coastal and pelagic, are now less resilient to additional pressures or changes. Bearing the cost of previous exploitation, new developments such as OTEC have to be implemented with particular care.

Compared to other marine activities, OTEC is special in terms of environmental impact. There is no other technology that works in comparable ways or interacts with the same deep sea ecosystems (Hammar 2014).

The OTEC technology is based on massive water exchanges (500–700 m³ per second for a 100 MW plant). Warm water from the surface and cold water from the depth is redistributed and its temperature is changed. Environmental effects much depend on where in the water column and how far from shore this effluent water is emitted. The intake flows also imply that marine organisms are entrained through the pipes or impinged on protective screens. These processes are the main potential drivers for environmental impacts of OTEC. However, detrimental effects can be

prevented through technical consideration when designing and locating OTEC plants.

Environmental impacts from water redistribution

The massive redistribution of water between different depths at an OTEC plant raises several concerns. In comparison to surface water of tropical seas, deep sea water has low temperature, high salinity and alkalinity, and high contents of nutrients and minerals. If the discharge water from OTEC is released and stays in the aphotic zone below 200 m depth impacts are likely to be small for a single OTEC plant, but if discharge water reaches the ocean surface layers, as a cause of inadequate design or unforeseen water movements, the alternation of the above mentioned water properties may generate large-scale ecosystem level impacts (Pelc and Fujita 2002, Boehlert and Gill 2010). This is because the conditions for organisms in coastal and upper pelagic environments change.

The possible intrusion of nutrient rich water into coastal ecosystems, such as coral reefs, has been considered particularly worrisome. Eutrophication from land runoff is known to have detrimental effects on coral reef ecosystems. Natural upwelling of cold nutrient rich water causes ecosystems very distinguished from those of nutrient poor warm tropical seas where most OTEC potential resides. So, in theory, the redistribution of deep sea water into surface water ecosystems will cause ecosystem change. But whether it will actually happen is essentially depending on the rate of dilution, which varies among cases. Oceanographic modelling is necessary.

Two similar and partly limited model works have recently become available. Considering a 100 MW OTEC plant offshore Hawaii, with a discharge depth of 70 m, Grandelli et al. (2012) concluded that ecological effects of nutrient displacements in surface waters would be negligible. In a similar study, Jia et al. (2012) likewise concluded that changes to the surface water would be negligible, but that nutrient levels would double below discharge depth (70 m). Here, it was argued that possible ecological effects further depend on whether the currents at this depth would dilute the nutrient concentration before phytoplankton growth takes place (Jia et al. 2012). The question of impact consequently remains.

What is clear though is that the discharge depth of OTEC plants needs to be thoroughly considered when designing specific OTEC schemes. Few OTEC plants will ever be built if the first ones are shown to ruin local coral reef ecosystems, all of huge importance for fisheries and biodiversity. Therefore, the expense of deeper discharge pipes must be considered part of the OTEC capital cost, and oceanographic modeling must be taken to detail during planning.

Environmental impacts from water intake

The water exchange of OTEC also implies that marine animals will be entrained through the system and impinged at the intake separation screens (Pelc and Fujita 2002, Comfort and Vega 2011). At the warm water intake, at about 20 m depth or so, planktonic organisms are entrained through the system. This includes also planktonic eggs and larvae of fish and invertebrates. Entrained organisms suffer from pressure change, temperature shock, possible antifouling agents and altered environment at release point. Considering that the surface water intake flow is about 400 m³ per second losses of planktonic organisms can be huge if the intake is located where abundances are high. For comparison, the combined surface water intake of Swedish nuclear plants is in the same order of magnitude (400 m³ per second) and has been estimated to cause losses of several hundred tons of adult fish and even higher amounts of fish eggs and larvae (Bryhn 2012). The level of impingement, in turn, depends on separation screen mesh size and intake water approach speed. With large mouthpiece diameters at least larger fish and other swimming animals will be able to avoid impingement. At the cold water intake, however, maintenance of separation screens is complicated and screens have therefore not been considered on early OTEC designs. Such lack of separation screens at the deep water intake means that deep sea organisms of any size easily can be entrained. Samples from an OTEC pilot plant have shown entrainment of anglerfish and several other deep sea animals (Comfort and Vega 2011). Without effective deep water intake screens OTEC full scale plants may have unforeseen effects on deep sea fauna. Deep sea organisms are thought to be particularly vulnerable due

to slow reproduction rates and limited resilience to environmental changes (Glover et al. 2010, Ramirez-Llodra et al. 2011).

Technical consideration is again needed to avoid substantial losses of marine organisms, such as fish and coral recruits from surface waters and large deep sea creatures from the deep. This includes large mouthpieces and fine mesh separation screens at surface water intakes, and at least some sort of separation screens at the deep water intake.

Using OTEC deep sea water for mariculture?

It is often suggested that the nutrient rich cold water pumped up from depth by an OTEC plant could be used for mariculture purposes. While it is true that ecosystems characterized by upwelling are productive this effect cannot be really reproduced at the scale of an OTEC plant. Marine ecosystems are interconnected through complex patterns of currents and migration and do not function at the same scale as the influence area of an OTEC plant. Most species or populations would not be able to adapt to utilize an isolated area of nutrient rich cold water. Rather, the effect of releasing deep sea water in coastal areas would be the loss of natural ecosystems such as coral reefs and seagrass meadows, adapted to warm nutrient poor environment. Ecosystem impacts similar to other means of eutrophication would be to expect. Thus, it might be necessary to settle with the immense benefits OTEC can bring in terms of fresh water and electricity, and to leave the nutrient rich cold water back to the deep ocean after use. At all circumstances, any mariculture related utilization of the nutrient rich water requires careful consideration and risk awareness.

OTEC and environment: a wider perspective

Importantly, the environmental concerns discussed above can essentially be solved by adaptation and limitation during the design and implementation of OTEC plants. As a potent source of renewable power, OTEC technology also carries great indirect benefits for the marine environment, as well as for the environment at the whole. The current level of carbon dioxide emission is a huge threat and potentially a looming disaster for marine ecosystems,

mostly because of ocean acidification but also because of other climate change effects. For instance, the oceans are currently absorbing the vast majority of anthropogenic carbon dioxide emissions, making the oceans increasingly acidic at rapid pace (Field et al. 2014). At the point where animals in the base of the food web are prohibited to bind calcium into shells and skeletons, ecosystem collapse or irreversible change are likely to occur. Any dampening of this anticipated event chain must be considered an important measure. The resource potential of OTEC is huge (Sandén et al. 2014). Therefore, a massive – but still considerate – expansion of the technology would likely be an important step towards sustainable global energy supply.

Linus Hammar wrote both his licentiate and doctoral theses on energy resources for developing countries, combining environmental and energy research. Substantial parts of these works are devoted to OTEC. Dr. Hammar now works for the Swedish Agency for Marine and Water Management in Gothenburg.

References

- Boehlert, G. W. and A. B. Gill. 2010. Environmental and ecological effects of ocean renewable energy development: A current synthesis. *Oceanography* 23:68-81.
- Bryhn, A. 2012. Fiskförkluster i svenska kärnkraftverk. Energimyndigheten, Elforsk rapport 12:50.
- Comfort, C. and L. A. Vega. 2011. Environmental Assessment for Ocean Thermal Energy Conversion in Hawaii. Pages 1-8 *in* *Oceans 2011*, Waikoloa, US.
- Field, C. B., V. R. Barros, D. J. Dokken, K. J. Mach, M. D. Mastrandrea, T. E. Bilir, M. Chatterjee, K. L. Ebi, Y. O. Estrada, R. C. Genova, B. Girma, E. S. Kissel, A. N. Levy, S. MacCracken, P. R. Mastrandrea, and L. L. White. 2014. Climate Change 2014: Impacts, Adaptation, and Vulnerability. Part A: Global and Sectoral Aspects. Contribution of Working Group II to the Fifth Assessment Report of the Intergovernmental Panel on Climate Change - Summary for Policymakers. IPCC, Cambridge, United Kingdom, and New York, NY, USA.
- Glover, A. G., A. J. Gooday, D. M. Bailey, D. S. M. Billett, P. Chevaldonne, A. Colaco, J. Copley, D. Cuvelier, D. Desbruyeres, V. Kalogeropoulou, M. Klages, N. Lampadariou, C. Lejeune, N. Mestre, G. L. J. Paterson, T. Perez, H. Ruhl, J. Sarrazin, T. Soltwedel, E. H. Soto, S. Thatje, A. Tselepides, S. Van Gaever, and A. Vanreusel. 2010. Temporal change in deep-sea benthic ecosystems: a review of the evidence from recent time-series studies. *Advances In Marine Biology* 58:1-95.
- Grandelli, P., G. Rocheleau, J. Hamrick, M. Church, and B. Powell. 2012. Modeling the Physical and Biochemical Influence of Ocean Thermal Energy Conversion Plant. US Department of Energy, Makai, US.
- Halpern, B. S., S. Walbridge, K. A. Selkoe, C. V. Kappel, F. Micheli, C. D'Agrosa, J. F. Bruno, K. S. Casey, C. Ebert, H. E. Fox, R. Fujita, D. Heinemann, H. S. Lenihan, E. M. P. Madin, M. T. Perry, E. R. Selig, M. Spaldig, R. Steneck, and R. Watson. 2008. A Global Map of Human Impact on Marine Ecosystems. *Science* 319:948-952.
- Hammar, L. 2014. Power from the Brave New Ocean - Marine Renewable Energy and Ecological Risks. Chalmers University of Technology, Gothenburg. Available at: <http://publications.lib.chalmers.se/publication/196091-power-from-the-brave-new-ocean-marine-renewable-energy-and-ecological-risks>.
- Jia, Y., G. C. Nihous, and K. J. Richards. 2012. Effects of ocean thermal energy conversion systems on near and far field seawater properties—A case study for Hawaii. *Journal of Renewable and Sustainable Energy* 4:-.
- Pelc, R. and R. M. Fujita. 2002. Renewable energy from the ocean. *Marine Policy* 26:471-479.

Ramirez-Llodra, E., P. A. Tyler, M. C. Baker, O. A. Bergstad, M. R. Clark, E. Escobar, L. A. Levin, L. Menot, A. A. Rowden, C. R. Smith, and C. L. Van Dover. 2011. Man and the Last Great Wilderness: Human Impact on the Deep Sea. PLoS ONE 6:e22588.

Sandén, B., L. Hammar, and F. Hedenus. 2014. Are renewable energy resources large enough to replace non-renewable energy? *in* B. Sandén, editor. Systems perspectives on Renewable Power. Chalmers University of Technology, E-book.

Smith, H. D. 2000. The industrialisation of the world ocean. *Ocean & Coastal Management* 43:11-28.

A case study of a hypothetical 100 MW OTEC plant analyzing the prospects of OTEC technology

Dr. Subhashish Banerjee, India, Formerly of Coventry University, UK,

Dr. Les Duckers, Coventry University, UK,

✉ Dr. Richard Blanchard, Loughborough University, UK

Abstract

A hypothetical case study has been made of a 100 MW OTEC plant, which would require around 400 m³/sec of warm water feed (with 200 m³/sec of cold water feed) and resulted in the following data:

- ♦ CO₂ saving compared to coal power plant, as determined from lifecycle assessment (LCA) studies, would be 98.62 % for CC-OTEC, 97.41 % for the hybrid type, and 94.4 % for OC-OTEC.
- ♦ Energy payback period value would be 1.33 years.
- ♦ Cost of power generation from NPV concept of such plant is estimated to be of 2.9 p/kWh.
- ♦ 172,800 m³ of potable water/day could be available from OC-OTEC (but none from CC-OTEC though a hybrid type may yield appreciable potable water).
- ♦ More than 68,000 kg shellfish/day could be availed for all types of 100 MW OTEC.
- ♦ Upwelling of the nutrient rich cold water along with abundant plankton from sea-bottom and the mixed discharge of it in the ocean during OTEC operations is likely to help growth of the oceans' flora and fauna for the abundant supply of seafood. But the danger posed from simultaneous upwelling of toxic algal bloom endangering the marine species, are also apprehended. However, by and large positive marine species growth has been opined.

- Such increased species growth becomes instrumental in burying CO₂ in the deep ocean floor with the carcasses of dead marine species grown. This phenomenon known as sequestering of CO₂, appreciably increases the ocean's CO₂ storage capability and thereby in addressing the problem of global warming. This is in addition to the amount of CO₂ saved from use of alternate energy source on OTEC, against the conventional fossil fuel resources.
- Upwelling of cold water may be utilized in cold storages/air conditioning saving 600 times the power required for running the same.
- Hydrogen production, as may be made at expense of the net power generated, from a 100 MW plant, would amount to over 35,000 kg/day or 20,000 kg of NH₃/day.
- 21,773 kg of CO₂/day from OC-OTEC (also from the hybrid type but not for CC-OTEC) would be available, which can be utilized as raw material for soda ash manufacture/urea production (along with NH₃ as may be availed from H₂ production). Also a huge quantity of oxygen enriched air – near 33 % O₂ content, against 20.93 % of normal air may be availed.
- 188,812 kg/day of methanol utilizing the H₂, as may be generated can thereby be the resource raw material for petrochemical industries, opening up the scope of availability of a chemical hub in the vicinity of the OTEC plant.
- Such OTEC plants can help sustainable development, particularly small island developing states (SIDS), arresting coral bleaching (decreasing acid rains etc.), and generating employment; and also help in reducing global warming from sequestering of CO₂, in addition to saving CO₂ emission compared to conventional fossil fuel power generators.

Keywords

OTEC, Life Cycle Assessment, Energy Payback Period, CO₂ saving, Net Present Value, Plankton, Marine species, Sequestering of CO₂, Coral bleaching.

Corresponding author: Dr Subhashish Banerjee, E-mail: <wave.banerjee@gmail.com>

Introduction

It has been noted that the net power availed from OTEC is considered to be around 65 % of the gross power generated (Vega 1999). It is also a fact that the capacity factor of OTEC technology has been considered to be around 80 %, even from a modest estimate of it (Varley 2013). Thus the net annual power generation from 100 MW OTEC plant would be: $100 \times 24 \times 365 \times 0.8 \times 0.65 \text{ MWh} = 455,520 \text{ MWh} = 455.52 \text{ GWh}$, or a daily net power production of 1.248 GWh. Considering an OTEC plant life to be about 30 years, its life time net power production would be

$$455.52 \times 30 = 13,666 \text{ GWh} \quad [1]$$

Keeping in view the above data on power generation from a 100 MW OTEC scheme, the following prospects of it have been assessed in the present study. They are:

- The carbon foot print – giving the scope of CO₂ saving achievable compared to a coal power plant. The estimations are made from the life cycle assessment studies.
- Energy accounting studies – to determine the energy payback period of the concerned OTEC plant.
- Environmental aspects – including the changes caused over oceans flora & fauna, hazards as may be posed from the placement of the concerned OTEC plant (also with recommendations for preventing the potential hazards), and the various dimensions on societal influences caused from its application.
- The economic issues involved; determining the cost of power generation/kWh, as also of the benefits derived from the prospect of number of byproducts, as may be available.

The above studies have been elucidated in the following sections.

Life cycle assessment (LCA) on carbon foot print and energy accounting (EA) studies of the 100 MW OTEC plant

Life time emission of CO₂ expressed in g/kWh power generation of an energy device, as per LCA estimations, would be

$$\sum Gi \times Mi/Pl + \text{operational stage emission in g/kWh.} \quad [2]$$

In the above equation, Gi represents the gas emission in kg/kg of the inventory items; Mi is mass of the inventory items of the device; and Pl is the life time power generation of the device, expressed in kWh. Unlike all other renewable energy systems, in case of OTEC systems, operational stage emissions are required to be taken into account in the LCA studies.

The LCA studies are carried out as per ISO 14040 with boundary conditions 'from cradle to grave'. The data Gi, giving emission characteristics of concerned inventory items, have been taken from the Bath University database (Hammond & Jones 2008) and the inventory items are taken from a hypothetical Japanese model of a 100 MW CC-OTEC plant (Tahara et al. 2000).

The emission of CO₂ (except its operational stage emission), for the 100 MW OTEC plant has been estimated based on the above data and as per the equation [2]. The results are shown below in Table 1.

Table 1. CO₂ emission of constructing a 100 MW CC-OTEC plant estimated from the Bath University database.

Inventory materials	CO ₂ emission kg/kg**	Mass of the material (kg)***	Total CO ₂ emission estimated (kg)
Steel (different types)*	6.15	4,157,000	25,565,550
Copper	3.00	270,000	810,000
Iron	1.91	16,817,000	32,120,470
Plastics	2.53	14,216,000	35,966,480
Cement	0.83	75,000,000	62,250,000
Grand Total		110,460,000	156,712,500

* (mean values considered); ** (Hammond & Jones 2008) *** (Tahara et al. 2000)

Thus the CO₂ emission (excluding operational phase emission) would be

$$156,712,500 \text{ kg}/13,665.8 \text{ GWh} = 11.46 \text{ g/kWh.} \quad [3]$$

Scope of CO₂ emission during operational phases of OTEC

As regards CO₂ emissions from operational phases in OTEC, there can be two possible sources. The first one is from its evolution from warm sea water during steam formation, along with the permanent gases like O₂ and N₂ where warm water is used as the working fluid, as in OC-OTEC. In hybrid cycles where warm water is used for providing potable water, CO₂ (g) emission occurs during steam formation of warm sea water. The second source of CO₂ (g) emission in OTEC operation is from the possibility of its liberation from cold water, when its temperature gets elevated in the condenser and is discharged in the ocean mixed with warm water.

In fact, the solubility of CO₂ in water is inversely proportional to the temperature and directly proportional to the pressure in the ocean (Teng et al. 1996). It may be relevant to add here, that despite the fact that the solubility of CO₂ (g) decreases with salinity of the water, the role of the ocean is considered quite important in maintaining the atmospheric CO₂ (g) concentration balance (Enrick and Scott 1990). In fact, CO₂ (g) from air after dissolution in ocean water remains in the form of soluble carbonates, bicarbonates as well as in gaseous form, depending on the temperature and pressure following Henry's law. Upwelling of cold water is likely to release this dissolved gaseous CO₂, on temperature rise and also for lowering of the super incumbent pressure of the water.

The role of organisms such as plankton is also to be considered while deciding maintenance of equilibrated concentration of CO₂ in the ocean water. They consume CO₂ during photosynthesis and also in the formation of shells. The dead cells of these and the marine species feeding on them thereafter sink with enriched carbonate content. This phenomenon of CO₂ burying by dead species – at the ocean floor and thereby maintaining CO₂

balance in the global environment – by the ocean’s natural process is termed sequestering of CO₂ (Christopher and Barry 2008).

The churning of the ocean caused by OTEC deployment, with the artificial upwelling of cold water as well as their discharge in the euphotic zone of the ocean as the mixed discharge (with warm and cold water), may affect the CO₂ balance of the ocean. This may be caused by fluctuations of the following three factors:

1. temperature elevation/lowering
2. pressure release, and
3. plankton concentration.

It would be expected that a rise in plankton concentration in the surface layer from the upwelling of cold bottom layer water would help lowering the GHG gas level in the atmosphere, consuming more CO₂ over ocean surface water. On the other hand, a huge quantity of dissolved CO₂ (g) is likely to be released from temperature rise and the pressure release of the upwelled cold water.

As a matter of fact, Green and Guenther (1990) noted from their experimentations in the Heat and Mass Transfer Scooping Test Apparatus (HMTSTA), that evolution of CO₂ from operations in case of OC-OTEC is expected to be 11.7g/kWh from warm water and 26.8 g/kWh from cold water; totaling 38.5g/kWh. In the case of hybrid OTEC it is expected to be lower, 11.7g/kWh, and a still lower value of <1g/kWh for operations with CC-OTEC (Green & Guenther 1990). They however argued that if this cold water instead of getting discharged into the ocean is used for mariculture, it would emit more CO₂ (g) for its longer exposure. But the cultured marine plants etc. are likely to absorb the extra CO₂ (g) released and thus neutralize it (Green & Guenther 1990).

In the present study, CO₂ emission during the working phase, for CC-OTEC, OC-OTEC and hybrid OTEC types, were estimated, based on the above stated studies of Green and Guenther (1990) as per their experimentations on HMTSTA, which showed:

- ♦ 38.5g/kWh for OC-OTEC,
- ♦ 11.7g/kWh for hybrid type, and
- ♦ <1g/kWh for CC-OTEC (say 0.8g/kWh) [4]

It may be relevant to add that for 100 MW CC-OTEC, the operational stage of CO₂ input as accrued from the working fluid (NH₃) is also to be taken into account; which is reported to be 222,000 kg (1.11 kg CO₂/kg of NH₃) by Japanese researchers (Tahara et al. 2000). Thus in terms of g/kWh emission of NH₃ for CC-OTEC would be

$$2,220,000 \text{ kg}/13,665.8 \text{ GWh} = 0.16 \text{ g/kWh.} \quad [5]$$

The inventory items of OC-OTEC would vary from that of CC-OTEC, because OC-OTEC would require a much larger evaporator, requiring a larger amount of material inputs. On the other side, its use of a DCC heat exchanger would cause much less material input than that used for metal surface heat exchangers, used in CC-OTEC. Hence it may be considered that the two inputs (positive and negative) would by and large balance each other. Thus, CO₂ emission from inventory item inputs of OC-OTEC may be considered to be more or less similar to that of the inventory items of CC-OTEC.

Total CO₂ emission from OTEC plants vis-à-vis other energy systems

Based from the relationship of [3], [4] & [5] –

- CO₂ emission from a 100 MW CC-OTEC plant
= (11.46+0.8+0.16)g/kWh = 12.42 g/kWh
- CO₂ emission from a 100 MW OC-OTEC plant
= (11.46+38.5) g/kWh = 49.96 g/kWh
- CO₂ emission from a 100 MW hybrid OTEC plant
= (11.46+11.7+0.16)g/kWh = 23.32 g/kWh

Based on LCA studies of a typical coal power plant, CO₂ emission has been noted to be 900 g/kWh (Odeh & Cockerill 2008).

In comparison to such a coal power plant, percent of CO₂ emission saved from a renewable energy (RE) device would be

$$100-[Ce/900]\times 100 \quad [6]$$

where C_e is the CO_2 emission in g/kWh of the concerned RE device.

Accordingly:

- CO_2 percent saved for a 100 MW CC-OTEC plant
= $100 - 1,242/900 = 98.62\%$
- CO_2 percent saved for a 100 MW OC-OTEC plant
= $100 - 4,996/900 = 94.45\%$
- CO_2 percent saved for a 100 MW hybrid OTEC plant
= $100 - 2,332/900 = 97.41\%$

Thus, CO_2 saving for 100 MW OTEC varies between 98.62 and 94.45 percent.

Energy accounting studies

Calculating the energy payback period (EPBP) from energy accounting studies enables to determine the total energy production in years which is required to manufacture the concerned product. This can be determined as per the following equation:

$$EPBP = \sum E_i M_i / P_a \quad [7]$$

where E_i is embodied energy of inventory items of the device expressed in MJ/kg; M_i is their respective mass in kg, and P_a is the annual power generated by the 100 MW OTEC plant, also expressed in MJ.

The above data required for EPBP estimations, as obtained from different data sources of Bath University (Hammond & Jones 2008) – are shown in Table 2.

Assessment on environmental aspects from deployment of a 100 MW OTEC plant

Besides emission aspects, as determined from LCA studies elucidated above, environmental issues involve assessment of the following topics:

- Changes over oceans flora and fauna and impact parameters influencing them.

Table 2. Energy requirement data of 100 MW OTEC for EPBP estimation.

Inventory materials	Mass of materials (kg)*	Embodied energy = E_i MJ/kg (Bath data)**	Total embodied energy = $E_i \times M_i$ (Bath data) MJ
Steel (different types)	4,157,000	56.7	235,701,900
Copper	270,000	50	13,500,000
Iron	16,817,000	25	420,425,000
Plastics	14,216,000	80.5	1,144,388,000
Cement	75*106	4.86	364,500,000
Grand Total	11,046*104		2,178,514,900
* (Tahara et al. 2000); ** (Hammond & Jones 2008)			
EPBP = $2,178,514,900 \text{ MJ} / (455,520 \times 3,600) \text{ MJ} = 1.33 \text{ years}$			
(Pa = Annual power generation, being 455,520 MWh)			

- Vulnerability, highlighting the hazards posed and also making recommendations for their prevention.
- Societal issues involved making necessary changes from large scale deployment of OTEC schemes.

They are elucidated as below.

Assessment over oceans' flora and fauna

In order to determine the influence of the large scale deployment of OTEC over the oceans' flora and fauna, it is extremely important to identify the impacting parameters that are decisive in the growth of marine species.

The ocean may be considered to have overlapping temperature layers with varying water density extending to different depths in the ocean. Oceanic species of different types have their own preferred thermal zones of habitat. It is also a fact that most of the marine life thrives in the sunlit portion or euphotic zone in the ocean, though this zone constitutes a rather small portion of the bulk of ocean water.

The abundance of marine species would of course depend on the scope of availability of the nutrients in their habitat for survival and growth. Since the micro, nano and pico plankton, termed phytoplankton, are building

blocks in the food chain web of marine species, the factors influencing their growth ultimately decides the growth and abundance of marine species in their concerned habitat (Quere et al. 2005). The growth of these plankton species are facilitated in the upper euphotic zone of the ocean until a penetration of around 10 % sunlight is availed. This extends to a depth of 20-80 m from the surface depending on turbidity of the ocean concerned. The nutrients needed for the growth of phytoplankton are dissolved nitrogen, phosphates and other mineral matters in the ocean water. Unless the nutrients are replenished, their growth stops (Quere et al. 2005).

Thus the impacting parameters influencing the growth of marine species would depend on:

- ◆ Temperature of the particular zone of the ocean water.
- ◆ Concentration of planktons with availability of sunlight.
- ◆ Availability of abundant nutrients such as dissolved mineral matter.
- ◆ Nitrogen, phosphates etc. in the concerned zone of the ocean water.

The large production of shellfish was observed on the west coast of South America because of the upwelling of nutrient rich bottom cold water coming to the surface from the Humboldt Current of the ocean (Anderson 1998). Roels thereby could promote the production of fish by pumping water from 800 m depth in the ocean (Roels 1980). He estimated that a 100 MW OTEC plant, from its upwelling of 136 m³/sec of cold water, can yield a yearly production of 25,000,000 kg shellfish meat (Roels 1980).

This single factor for the upwelling of cold water from depth, required for OTEC operation, would bring rich nutrients and mineral matter to the euphotic zone of the ocean. This would thereby facilitate the growth of all sea-animals, including fish populations, which is a major protein food source for human consumption. It is also to be noted that the upwelling of nutrient rich cold water may stimulate some agents which might be toxic to certain marine species. They could be from harmful algal blooms (HABs), depending on the site and seasonal variations (Pitcher et al. 2010). However, by and large the upwelling of cold water has been argued to help the overall growth of marine species (Takahashi 2003).

Chlorine feed in heat exchangers (to tackle the bio-fouling problem in OTEC plants), when spilled into the ocean with mixed discharge of warm-

cold sea water, might have a detrimental effect on marine life. But the required dose of chlorine feed to a maximum of 0.5 ppm is well below the level prescribed by Environment Protection Agency's (EPA, USA) limit of chlorine pollution of species (Vega 1999).

In OC-OTEC as well as in the hybrid type, evaporation of water to steam (though to a small extent) for availing potable water, would enrich the mineral concentration of the outlet warm water in the mixed discharge. This puts OC-OTEC (and also the hybrid type) in a rather more advantageous position for species growth than CC-OTEC, with the former providing a little more extra nutrients.

The running of a 100 MW OTEC plant requires a huge flow of warm and cold water feed (around 400 m³/sec and 200 m³/sec, respectively), which with its mixed discharge in the ocean has been compared as the "nominal flow of river Colorado in the Pacific"(Vega 2002/2003). This churning of the ocean with a huge water flow at a temperature differential of around 20 °C round the clock is likely to create mist formation around the plant. This could then affect migratory birds and also of the bird population who are affected even from high wind towers if it falls in their migratory routes (Langton et al. 2011).

The laying of cold water pipe lines at the ocean floor (with foundations for maintaining stability), in case of shore based plants may affect the Benthos population, which thrive in the ocean floor. But compared to the vast ocean floor area its effect would be marginal, in the vicinity of pipe line only.

All the above points are to be kept in view in assessing the flora and fauna for CC-OTEC, OC-OTEC, and for the hybrid types. The flora and fauna thus considered for assessment are as below:

- ◆ Birds
- ◆ Fish
- ◆ Sea mammals
- ◆ Plankton
- ◆ Benthos community.

EIA impact assessment results for each of the above species, as derived from the above discussions on the influence of impacting parameters over them, are shown in Table 3 for all three types of OTEC devices.

Hazards posed from OTEC plants

The hazards posed particularly specific to OTEC system mostly originate from the following three sources:

- Inherent limitation in the construction of the OTEC device itself, thereby off-setting its stability and survivability.
- Malfunctioning and/or failure of parts of the OTEC plant, requiring particular attention and periodic maintenance.
- Risk of causing huge damage to the OTEC device from extraneous factors like natural disasters, sea storms/hurricanes/earthquakes etc.; and from collision of off-shore or grazing OTEC plants with marine liners.

Preventive measures on hazards related to construction aspects of OTEC

The overhanging cold water pipes are to be attached through the central portion of the platform of the huge bodied OTEC plant, with the warm water and mixed discharge pipes fitted at two sides, ensuring stable C.G. of the structure (Bergman 1996). In fact, submersible OTEC devices with most of the structure submerged and C.G. below the ocean surface, ensures better stability even in storms, though it involves higher cost with problems in operation & maintenance. Submersible OTEC plants are, however, still

Table 3. EIA score values of flora and fauna from OTEC deployment*

OTEC Type	Birds	Fish population	Sea mammals	Plankton	Benthos
CC-OTEC	L-	M+	M+	H+	L-
OC-OTEC	L-	M+	M+	H+	L-
Hybrid type	L-	M+	M+	H+	L-

*M+ = moderate positive; H+ = high positive – may consist of phytoplankton of both types, helpful (to species growth) and toxic types; L- = low negative.

in the R&D stage of development (Takahashi 1999).

As per the norm of use in oil rigs the pipe should not be rigidly attached to the OTEC platform, but kept flexible. It may then hang vertically, uncoupling from the platform which itself may swing violently in high storms (Anderson 1998). The construction of the pipes should be with flexible materials (rubber like substance known as elastomers) with jointed sections so that it does not yield from the stress of ocean currents (Cohen 1982).

The cable laying below a depth of 600 m poses a problem, which is why in-situ manufacture of fuels like H_2 and/or NH_3 are recommended instead, on development of grazing type OTEC (Ryzin et al. 2005). This also saves the cost of long distance cables required and averts transmission loss. However, such scheme (grazing OTEC for H_2 , etc) is still in the R&D stage.

Land-based plants are rather advantageous in this respect, requiring no mooring cost nor, cable laying for power transmission.

Malfunctioning of an OTEC plant

The sources of malfunctioning of OTEC operations with measures to minimize them are presented below:

- Obviating bio-fouling of heat exchangers by chlorine injection as well as periodical mechanical brushing minimizes the formation of scales so that the efficiency of heat exchangers are not affected.
- The hazard from accidental leakage of Cl_2 (g) storage may however affect plant workers, for which in situ preparation for Cl_2 feed is suggested.
- Discharge of warm and cold water mix is to be made at the right depth (>60 m), so that the heat resource of warm surface water layer does not get affected by cooler mixed water discharge.
- The NH_3 supply/storage (for CC-OTEC) should be properly secured, so that it does not cause leakages affecting plant workers.
- Adequate drainage/safety provision should be kept ready for sudden failures or leakages of the huge warm water/cold water pipe line. In case of pipe burst/leakage, the plant's production as well as the safety of operational staff will be affected.

- ♦ Usual precautions as used in common steam power plants are to be maintained, though the risk in OTEC is much less (even in OC-OTEC or hybrid OTEC) since OTEC plants only use low pressure steam.

It may be added that the above measures can only minimize the risk, but not totally eliminate them.

Extraneous risk factors

The experience of construction with the operation and mooring of oil rigs, which are functioning without any interruptions, despite ocean storms and hurricanes, is an important technological advancement, from which adequate countermeasure guidelines for OTEC schemes can be adopted. Of course there remain no fool-proof measure to counteract natural disasters. In fact, OTEC's early sea trial experiences are not encouraging with history of its earlier trial plants being wiped away by sea-storms.

Land based plants provide better safety in this aspect. Proper site selection should also be made avoiding earthquake prone zones and storm prone zones, as far as practicable.

As regards averting collisions from the movement of ships, it is better to choose off-shore OTEC sites away from ship movement routes, as well as maintaining light signals for off-shore OTEC sites, with moving fog lights which could be visible and signaled from a distance.

Societal influence from OTEC's deployment

The societal impact from OTEC, in its various aspects, should be judged both from a wider spectrum of global influence and from its local influence in the vicinity of OTEC plant deployment. Since OTEC opens up the availability of various byproducts, it also opens up the scope of employment generation, and making OTEC technology instrumental in improving the quality of life of the locality.

In addition, it ensures long term improvement in a much wider perspective with global implications from its environment friendly phenomenon, such as an increase in sequestration of CO₂ and lowering the risk of coral bleaching (averting ocean acidification).

The societal implication of the above input from OTEC, in addition to the aspects as regards noise pollution, visual impacts etc., are discussed below.

Sequestering of CO₂

It has already been discussed in previous sections of LCA as well as in discussion on influence over oceans flora & fauna, as to how the upwelling of cold water helps in increasing phytoplankton growth hugely. It then becomes instrumental in burying CO₂ deep in the ocean floor, with the carcasses of dead marine species grown, termed sequestering of CO₂. This phenomenon from the upwelling of water (needed for OTEC operation) could hugely increase the ocean's capacity for CO₂ consumption (Falkowski 1997) and thereby help in maintaining the CO₂ balance in a global atmosphere. It thus can help to address the global warming problem, much better than perhaps any other energy forms, other RE schemes included.

It has been estimated that a suitably designed OTEC plant to up-well nutrient rich cold water to the maximum extent can sequester 10,000 metric tons of CO₂ per year per MW power generated (Christopher and Barry 2008).

Arresting Coral Bleaching

The increasing incidence of coral reef bleaching since the eighties endangers many of the small island developing states [SIDS]. In fact, corals are sensitive to even small temperature changes and ocean level rises, with increasing trend of global warming. This phenomenon of coral bleaching is caused mainly from global warming and ocean acidification. A sustained temperature rise of only 1-2 °C, causing a corresponding sea level rise, may be lethal to most of the coral islands between 20-30 °N (Buchheim n. d.). OTEC technology has good potential to counter this problem of coral bleaching, which is vital for the survival of SIDS (Binger n. d.).

Scope of Employment Generation from OTEC

OTEC opens up the scope of a manpower requirement from the following four sources:

1. Construction of the huge bodied OTEC units, including their accessories, would require a large amount of manpower deployment.
2. OTEC, unlike most other RE systems, would require manpower deployment for running the plant – in addition to the maintenance, repair and manufacture of spare parts.
3. The potential of producing a number of byproducts that can be generated from the operation of OTEC, such as potable water and carbonated water, offers scope for opening up chemical hubs on OTEC sites. This would facilitate employment generation to a great extent. OC-OTEC and hybrid OTEC would be more advantageous than CC-OTEC on this count.
4. Another important point to consider is the scope of increment of mariculture in quality and quantity offered from OTEC. This would have the potential of large employment generation, in addition to improving the quality of life in the locality.

It may also be added that power production itself opens up avenues for employment generation with economic growth.

Sources of Noise Pollution

In order to reduce the cost of the cold water pipe (CWP) its diameter is kept on the lower side. But at the same time it is required to maintain a huge water flow. This is achieved by increased water flow velocity, which may be more than 6 m/s (Takahashi 2003). Such high velocity water flow would cause vibrations in the CWP causing appreciable noise, except in the case of submersible plants. In the case of off-shore plants, the operational workers would experience the same noise from the CWP.

Source of noise experienced from warm water pipe (WWP) lines may not initiate appreciable noise for CC-OTEC. But for OC-OTEC and hybrid types, where warm water is used for steam formation, there could be appreciable noise caused from the sudden flush of huge masses of warm water through the narrow spouts of the evaporator.

The discharge pipe line is another source of noise generation for all types of OTEC plants. The heat exchangers are however likely to create less noise.

It may be relevant to add that such noise pollution for high capacity OTEC plants is likely to be experienced by the working staff, but not by the people in the vicinity, even in the case of land based plants. In extreme cases a sound dampener may be required to be fitted at vulnerable sound producing points, for creating a tolerable work environment for the OTEC plant operators.

Visual impact from OTEC implantation

It has been detailed in section dealing with the oceans flora and fauna, that the churning of the ocean from OTEC operation is likely to cause a cloud of mist surrounding an OTEC plant, the intensity of which may be more for off-shore plants causing a visual impact. In fact, it would need fog lights for sighting the position of off-shore OTEC plants signaling to vessels in the near area, as a safe guard against collision from en-route oil liners etc.

The above visual impact, for land-based plants, is likely to affect tourist attraction to the sea-shore.

Economic issues

OTEC's economy, covering all three types of OTEC systems, must be judged from the following two aspects of OTEC schemes. They are:

- ♦ Assessment with a commonly used economic tool, like the cost/kWh of power generation.
- ♦ Scope of availability of the byproducts from OTEC schemes, besides electricity generation, which are unique for OTEC systems.

The methodologies adopted for the above economic evaluation of OTEC schemes are detailed below.

Power generation cost of a 100 MW OTEC scheme

It is important to note that like all other ocean energy schemes, in case of OTEC also; a huge capital outlay is required in the initial stage of an OTEC

plant's successful application. But the plant starts earning profit, only after the lapse of a considerable period. Thus it is required to keep in view the depreciation of money invested, till it starts earning the profit.

In such estimations, when benefits are derived a long time after the investments have been made, Net Present Value (NPV) estimations are considered useful (Mathew 2006:209-231). Banerjee et al. (2011) showed that the cost of electricity from the NPV concept (only the generation cost considered – excluding the insurance cost, local taxes, profit margin etc.), can be estimated from the following relationship:

The cost of electricity production/kWh

$$= \{C_c + \sum_0^t [0.01x * C_c / (1+r)^t]\} / \{\sum_0^t [E / (1+r)^t]\} \text{ per kWh} \quad [8]$$

where C_c = capital cost, E = annual energy production, t = life period, r = discount rate considered, and operational cost = x percent of the capital cost C_c . It is to be noted that cost/kWh from NPV estimations would vary with changes in t and r .

Power generation cost of 100 MW OTEC, as estimated from the above premise, is shown below.

- The capital cost of a 100 MW CC-OTEC plant was reported to be \$242.1*106 (Ravindran 1999). On conversion to GBP this value would be = £242.1*106/1.88 = £128.776*106. (The exchange rate of GBP to US dollar was \$1.88 = £1 in these calculations. At the time of this writing, the ratio is more like 1.60, but the ratio changes rapidly).
- The operational and maintenance cost (C_o) is reported to incur an annual expenditure of 1.5 % of the capital cost (Vega 1992).
- E = The annual power generation of the said 100 MW CC-OTEC has been shown to be = 455.52 GWh.
- t = The life period of the plant = 30 years (approx).

Based on the above base data, the economic indices as determined considering 8 % discount rate and 30 years life time and employing the equation [8], as above:

- Capital cost = C_c = £ 128, 776, 000
- Annual O&M cost = C_o = £ 128, 776, 000 × 0.015 = £ 1,931,640

- Annual Production of electricity = $E_a = 455.52 \text{ GWh} = 455,520,000 \text{ kWh}$
- Discount factor = $DF = [(1 + 0.08)^{30} - 1] / [0.08 \times (1 + 0.08)^{30}] = 11.25778$, considering 8 % discount rate with 30 years life
- Present value of cost = $C_c + C_o \times \text{discount factor} = \text{£ } 150,521,978$
- Present value of energy = $455,520,000 \times 11.25778 = 5,128,143,946 \text{ kWh}$
- Cost/kWh = Present value of cost / Present value of energy = 2.9 p/kWh.

Prospects on potential of byproduct availability from 100 MW OTEC

The prospect of byproduct availability from OTEC, if pursued with necessary R&D efforts, may perhaps prove to be more lucrative than the power generated from it. The scope of availability of various byproducts from OTEC, with the possibility of deriving economic advantages include:

- Availability of desalinated potable water (from OC-OTEC or hybrid OTEC plants)
- Increasing scope of availability of mariculture proteins, agricultural products etc. from cold water feed and/or mixed water discharge feed, to land or water bodies of concerned locality on the OTEC deployment site
- Utilizing cold water for air conditioning, or for refrigerant purposes with much less power requirement
- Possibility for production of oxygen-rich air, soda water/ CO_2 enriched water, etc.
- Generation of chemicals like soda ash, urea, CH_3OH and hydrocarbons, as well as H_2 type fuels and NH_3 .

A brief description of the scope of their availability and also of the technical challenges, are discussed in subsequent sections.

Potable water

It is known that considering OTEC's thermodynamic efficiency to be around 2.5 %, 40 units of thermal energy would be required to generate 1 unit of electricity. Thus warm water circulation of an amount of 400 m³/sec at around 20 °C temperature differential is required for a 100 MW OTEC plant (Vega 2002b). With 0.5 % – 1 % of this water being evaporated to steam (required for running the turbine of the 100 MW OC-OTEC's generator), it would have the potential to produce 2 m³ to 4 m³ potable water per second, from the condensation of the steam in the condenser of the plant.

With this premise, production of potable water from 100 MW OC-OTEC can be expected to be $0.005 * 400 * 24 * 3,600$ m³/day, for round the clock plant operation = 172,800 m³/day.

It has been claimed that a 1.2 MW OC-OTEC plant could yield desalinated water amounting to 2,200 m³/day (Vega 1999). This byproduct yield is said to be increased to nearly double the amount, diverting part of the generated power for potable water production, yielding a reduced net power generation of 1.1 MW, but with an increased amount of the desalinated water as a byproduct to an amount of 5,150 m³/day (Vega 1999). In case of a hybrid plant, potable water production in its first stage of operation has been estimated to be 2,281 m³/day for net power production of 5.1 MW, which in the second stage could yield 4 times the above amount (Vega 1999).

In fact, an actual sea trial undertaken for OC-OTEC in Hawaii between 1993-98 showed, it could produce 0.4 l/sec of desalinated potable water as a byproduct from its net electricity production of just 103 kW net power (Vega 1999).

Growth of mariculture & agricultural products

All three types of OTEC plants (land based ones mainly), have the potential to improve considerable growth of both mariculture and agricultural products, from their enriched nutrient laden up-welled cold water. This improvement could be achieved both in quality and in quantity.

As regards the agricultural growth is concerned, the nutrient rich cold water feed may increase the quantity wise growth for different agricultural products. Particularly profitable are the bio-pharmaceutical agricultural products and natural pigments like carotoids, etc. (Anderson 1998).

Mariculture farming includes production of lobster, salmon, crabs, tilapia, shellfish etc. (Binger n.d.) Studies conducted by University of West Indies Centre for Environment and Development (UWICED) showed that using up-welled nutrient rich water, the earning from mariculture could be increased more than 10 times than that earned from banana plantation and 30 times than that for sugar plantation, from equivalent land area used (Binger n. d.).

It has been estimated that annual growth of shellfish meat from the utilization of nutrient rich cold water of a 100 MW OTEC plant could be around 25,000,000 kg (Cohen 1982). It has also been estimated that implementation of 10,000 OTEC plants of 100 MW capacity would be able to meet the entire annual protein requirement for 2 billion people, considering an animal protein intake per person to be 35 g/day (Takahashi 2003).

It needs however be noted as a caution, that an unbalanced growth of mariculture may be detrimental to the mangroves and other ecosystems, vital for the stability of the coastal area (Ocean Thermal Energy Converter, Celestopian.d.).

On the other side, simultaneous increased growth of algae/kelp from nutrient rich cold water feed may affect certain species, and thus may affect the sea water's panorama. It is also a fact that along with mineral matter and other nutrients as may be upwelled from OTEC operations, simultaneous presence of certain toxic materials detrimental to certain marine species cannot be completely ruled out; unless proven from commercial scale field trials.

Too high a productivity of species with too much cold water upwelling and altering atmospheric CO₂ levels to too low a limit (from sequestering of CO₂) is also not desirable. It is the ocean's pH level and its surface water's CO₂ dissolution limit that strike a balance in a global climate –arresting both global warming as well as cooling beyond a limit. This balance should

not to be allowed to be disturbed too far. However, it needs practical field trials to make an objective assessment of these problems highlighted.

Cold storage/Air conditioning with up-welled cold water

It has been suggested that up-welled cold water, availed free as byproduct from all types of OTEC plants, could be fruitfully used as chilling fluid for cold storage and/or air conditioning plant.

In fact, in order to run a 1.1 MW OC-OTEC plant, the power requirement for up-welling the cold water feed is 3,085 kg/sec at 4 °C = 313 kW = 313,000 J/s (Takahashi & Trenka 1996). The energy required to cool the above quantity of water from an ambient level of 20 °C to 4 °C $\geq 3,085 * 4.186 * 1,000 * (20-4)$ J/s $\geq 206,620,960$ J/s. This is more than 660 times the power required for upwelling the same amount of water to the same temperature level of 4 °C. Thus, if this cold water or part of it is utilized for chilling plants, like cold storage or air conditioning plants (cooling only), one would save more than 600 times the power required for running the cold storage/air-conditioner.

It has been shown by Vega that only 1 m³/s of deep ocean water flow at 7 °C, requiring 360 kWe power, would be enough for air-conditioning 5,800 rooms in a hotel, saving power to the extent of 5,000 kWe (Vega 1995a).

It would be obvious that such advantage of utilizing up-welled cold water for cold storage/air conditioning would be economic for land-based OTEC plants only.

Production of O₂ enriched air and CO₂ (g) as industrial raw material

It may be of interest to examine the scope of availability of larger amounts of CO₂ (g) as a raw material of industrial products (water bottling plants etc.) as well as oxygen enriched air as a byproduct, from evolution of the gases like O₂, N₂, and CO₂, from OTEC operation.

In fact, in OC-OTEC and in hybrid operations, water soluble gases are evolved from warm water feed, due to steam formation from it, which is usually 0.5 % – 1 % of the total water feed. The other source is from the cold water feed in the condenser having DCC type heat exchangers, because

of the elevation of the up-welled cold water temperature as well as from the release of pressure, being raised from the bottom of the sea. The released gases containing O₂, N₂, and CO₂, are sucked out in the de-aeration chamber, so that they do not impair the efficiency of the DCC heat exchanger of the condenser.

A typical hypothetical case study has been undertaken for a 100 MW OC-OTEC, to determine the quantity and relative percentage of these gases which is virtually air, enriched with O₂ and CO₂, but with N₂ percentage less than that of air. This is because of the fact that the dissolution of the gases O₂, N₂, and CO₂ in the ocean remains in the proportion of 7 mg/l, 12.5 mg/l, and 90 mg/l, respectively (Floor 2006).

It is a fact that a 100 MW OC-OTEC plant would require a warm and cold water feed of 400 m³/s and 200 m³/s, respectively; with around 0.5 % of warm water being evaporated and sucked out in the de-aeration chamber (Vega 1999). Also part of the dissolved gases of up-welled cold water would evolve in the DCC condenser, from the release of pressure and elevation of temperature; the amount of which is presumed to be 0.4 % of the cold water feed.

Based on the above premise, relative production of the gases may be estimated from 100 MW OC-OTEC operation/day:

Gas release from warm water feed:

$$O_2 = 400 * 0.005 * 0.007 * 3,600 * 24 = 1,209.6 \text{ kg/day}$$

$$N_2 = 400 * 0.005 * 0.0125 * 3,600 * 24 = 2,160 \text{ kg/day}$$

$$CO_2 = 400 * 0.005 * 0.09 * 3,600 * 24 = 15,552 \text{ kg/day}$$

Gas release from cold water feed:

$$O_2 = 200 * 0.004 * 0.007 * 3,600 * 24 = 483.84 \text{ kg/day}$$

$$N_2 = 200 * 0.004 * 0.0125 * 3,600 * 24 = 864 \text{ kg/day}$$

$$CO_2 = 200 * 0.004 * 0.09 * 3,600 * 24 = 6,220.8 \text{ kg/day}$$

Total evolution of gases:

$$O_2 = 1,209.6 + 483.84 = 1,693.44 \text{ kg/day}$$

$$N_2 = 2,160 + 864 = 3,024 \text{ kg/day}$$

$$CO_2 = 15,552 + 6,220.8 = 21,772.8 \text{ kg/day}$$

Thus, the volume proportion of these gases are:

O₂: N₂: CO₂:: 0.098:0.2: 0.916 or,
8.1 %, 16.5 % & 75.4 %, respectively.

The high annual yield of CO₂ amounting to 21,772.8*365 = 7,947,072 kg/year, can be utilized not only for water bottling plants etc. of the availed potable water from OC-OTEC, but also in the manufacture of several byproducts – constructing necessary infrastructure; in cases where CO₂ is one of the ingredient raw materials.

Oxygen enriched air, as obtained could also find application in various fields.

Chemicals from OTEC

The above stated byproducts availed from OTEC plants are produced as byproducts because of the operational characteristic of OTEC. But there are certain products (chemicals) whose production is at the expense of electricity produced from OTEC, and are considered more profitable than just the production of electricity only. This includes production of fuels like H₂ and also chemicals like NH₃ from grazing OTEC, which however, is in the conceptual stage (Ryzin et al. 2005). In fact CO₂ (g) availed from OC-OTEC can also be utilized to produce chemicals whose ingredient raw material is CO₂ (g) – like manufacturing urea or soda ash.

Based on the availability of H₂, it may also be useful for the production of methyl alcohol with scope for synthesizing a host of different petrochemical products. A brief account of all of them is presented below.

Soda ash

In addition to the prospect of using the concentrated form of CO₂ (g) in water bottling plants, the other application could be in manufacturing Na₂CO₃, obtained by scrubbing CO₂ (g) with NaOH, as per the reaction:

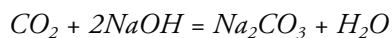

or, 44 g CO₂ would produce 106 g Na₂CO₃. Thus 7,947,072 kg CO₂ produced/year from a 100 MW OC-OTEC plant could yield Na₂CO₃ to an amount = $7,947,072 * 106/44$ kg/year = 19,145,219 kg/year.

But such availability of soda ash can only be possible provided the concentrated form of CO₂ (g) is not used in water bottling plants or for producing other chemicals.

It may be added that Soda ash may be manufactured from OC-OTEC and to some extent from hybrid types, but not from CC-OTEC.

Hydrogen

It has been reported that instead of transporting OTEC generated power, laying long sub-sea cables at 1000 m depth, it may be a cheaper and better option to use that power to split water and make in-situ generation of hydrogen, considered the most environment friendly fuel (Ryzin et al. 2005). There have been many R&D studies in progress, suggesting that the electrical input for hydrogen production by electrolysis from water splitting could be lowered with higher H₂ production. The advanced technology suggests using solid polymer electrochemical cell (SPE) with perfluorinated membrane as electrolyte (Nuttall 1977). Pure water (de-ionized water) is used to generate dry H₂ (g) from it.

It has been reported from a hypothetical deduction that a 64 MW OTEC plantship has the potential to manufacture 8,270 tons of H₂/year (Ryzin et al. 2005). In that case, it may be logical to deduce that a 100 MW OTEC plant would have the potential for annual production of H₂ to an amount = $(100/64) * 8,270 * 1000$ kg/year = 12,921,875 kg/year, or 35,402 kg/day.

Obviously, such production of hydrogen may be available from all three OTEC types, the amount of which is dependent solely on the OTEC plant's net power production.

Ammonia

It is to be noted that the biggest challenge of hydrogen (g) production lies in its storage, so that there is minimum leakage during transportation and its reaching to the end user. On the other side, the energy required for

transporting liquefied hydrogen would be nearly 10 times that of compressed hydrogen (g) (Ryzin et al. 2005). A cheaper option suggests transforming this hydrogen (g) to NH₃ (liq.) using Haber's synthesis as per the reaction:

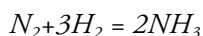

in the presence of a suitable catalyst. Nitrogen required for such ammonia production may be availed by stripping off oxygen from air.

This in-situ produced NH₃ (liq.) can then be transported as a hydrogen enriched chemical and/or as raw material for synthesis of various other chemicals.

Since as per stoichiometric equation in Haber's synthesis of NH₃ production, 6 g of H₂ produces 2 * 17g of NH₃ = 34 g of NH₃, hence its production from a 100 MW OTEC would be = 34 * 12,921,875/6 kg/year = 73,223,958 kg/year = 200,614 kg/day.

Like the production of hydrogen (g), ammonia can be availed from all the three types of OTEC plants.

Urea

This huge production of NH₃ (liq.) can fruitfully be utilized to make in situ production of various other chemicals, like the nitrogen rich fertilizer urea, taking advantage of the production of a highly concentrated form of CO₂ (g) produced as byproduct from OC-OTEC. In fact, the present practice for commercial production of urea requires ammonia and CO₂ (g) as raw materials. Both used to be derived from fossil fuel sources, like coal and/or natural gas.

Urea formation from these two raw materials proceeds as per the following reaction:

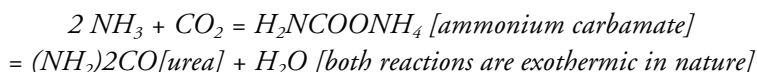

Thus, as per the above equation 44g CO₂ (g) interacting with 34g NH₃ can produce 60 g urea, in the presence of a suitable catalyst.

Since annual production of CO₂ (g) from OC-OTEC is 7,947,072 kg/year, as per estimations in section 11.4, it could interact with 7,947,072 * 34/44 kg of ammonia, or 6,140,919 kg ammonia to produce 7,947,072×60/44 kg urea = 10,836,916 kg urea/year.

However, production of urea can only be availed from OC-OTEC and partly from hybrid OTEC plants, not from CC-OTEC having no byproduct availability of concentrated form of CO₂ (g).

In addition to the above, all OTEC plants by virtue of their possibility of hydrogen production can synthesize a host of chemicals including petrochemicals, as discussed in the subsequent section.

Methanol & other petrochemical products

Methanol can also be manufactured as byproduct material from H₂, and this can be obtained by electrolysis of water utilizing the power generated from OTEC. The reaction would be the well-known synthesis of methanol from interaction of hydrogen with CO₂, as per the following reaction in presence of a Cu/ZnO/Al₂O₃ catalyst, viz. CO₂ +3H₂ = CH₃OH+ H₂O (Avery 1984).

A US patent No-4476249; suggests it to be prepared from interaction of H₂ with CO, in presence of a suitable catalyst; CO is said to be prepared processing CO₂ with carbon.

As per the above equation of methanol formation, 6 g H₂ yields 32 g methanol. Hence a 100 MW OTEC plant with annual hydrogen production of 12,921,875 kg/year can yield methanol to an amount = 12,921,875 * 32/6 kg/year = 68,916,667 kg/year.

The prospect of such production of methanol is available for all types of OTEC. In the case of OC-OTEC & hybrid types there remains the scope of availability of other reactants like the concentrated form of CO₂ (g), which can be produced in the case of CC-OTEC by burning carbon.

Scope of such methanol production from OTEC opens up the pathway of synthesizing a host of hydrocarbons and thereby growth of the petrochemical industry. Based on the above discussions, the prospect of availability of various byproducts from 100 MW OTEC has been summarized in the table below.

Table 4. Future prospect of byproducts from 100 MW OTEC

Byproducts	Daily Prod. (kg)	Remarks
Hydrogen	35,402	Availed for all OTEC types (at the cost of power generated)
Ammonia	601,840	Availed for all OTEC types (if H ₂ converted to NH ₃)
Methanol	188,812	Availed for all OTEC types (if H ₂ converted to methanol)
Shellfish etc	68,493	Availed for all types of OTEC
Potable water	172,800 m ³	Availed only for OC-OTEC and hybrid OTEC
CO ₂ (g) (as can be availed)	21,773	Availed only for OC-OTEC and hybrid type CC-OTEC
Urea	29,690	Can be used in water bottling Consuming all CO ₂ & part of NH ₃ produced from H ₂ . Can be availed only for OC-OTEC & Hybrid type, since require CO ₂ as one of the raw material
Excess NH ₃	183,789	Can be availed only for OC-OTEC & Hybrid type Excess NH ₃ available after Urea production
Soda ash	52,453	Availed only for OC-OTEC & Hybrid. Soda ash availed, for full CO ₂ use.

Inferences

A hypothetical case study of 100 MW OTEC plant, that would require around 400 m³/sec of warm water feed (with 200 m³/sec of cold water feed) resulted in the following data:

- CO₂ saving compared to coal power plant, as determined from LCA studies, was noted to be 98.62 % for CC-OTEC, 97.41 % Hybrid type & 94.4 % for OC-OTEC.
- Energy Payback Period value showed to be of 1.33 years.
- Cost of power generation from NPV concept of such plant was estimated to be 2.9 p/kWh.

Upwelling of the nutrient rich cold water along with abundant plankton and the mixed discharge of it in the ocean during OTEC operations is likely

to help growth of the oceans' flora and fauna for the abundant supply of seafood. Though the danger posed from simultaneous toxic algal bloom endangering the marine species, are also apprehended. However, by and large positive marine species growth has been opined.

Such increased species growth becomes instrumental in burying CO₂ in the deep ocean floor with the carcasses of dead marine species grown. This phenomenon known as sequestering of CO₂, appreciably increases the ocean's CO₂ dissolution capability and thereby in addressing the problem of global warming. This is in addition to the amount of CO₂ saved from use of alternate energy source on OTEC, against the conventional fossil fuel resources.

These plants help sustainable development, particularly small island developing states (SIDS), arresting coral bleaching (decreasing acid rains etc), employment generation; and also help in reducing global warming from sequestering of CO₂, in addition to saving CO₂ emission compared to conventional fossil fuel power generators.

Thus OTEC opens up a huge possibility of sustainable development if the minor challenges for its large scale commercial applications are met, may be in 2nd generation, 3rd generation OTEC schemes.

After graduating with Physics (Hons) from St Xavier's College, Dr. Banerjee did his masters in Energy Management (PGDEM) at a premier management institute, IISWBM, India, and his PhD at Coventry University, UK, on Environmental Science as the major topic; thesis called "Ocean Energy Assessment – An Integrated Methodology". The expertise gained during academic pursuits are in Life Cycle Assessment & Energy Accounting studies, Environmental Impact Assessment aspects, Sustainability Development (mathematical modeling), and Ocean Energy Systems.

References

- Anderson, J.H., (1998) Ocean thermal power, The coming energy revolution. Unpublished Booklet. York, Pennsylvania: Sea Solar Power, Inc, 1-38
- Banerjee, S., Duckers, L.J., Blanchard, R.E. and Choudhury, B.K., Ocean Energy Systems: Economy Evaluation, *Encyclopedia of Energy Engineering and Technology*. (Taylor & Francis), 21st October 2011, pp. 1-8, ISBN 978 0 8493 3896 0. (online publication)
- Bergman, G., B., (1996) Ocean Thermal Energy Conversion Platform. US Patent No 5,555,838. Date of patent: Sept. 17, 1996
- Binger, A.,(n.d) Potential and Future Prospects for Ocean Thermal Energy Conversion (OTEC) in Small Islands Developing States (SIDS), available from <http://www.SIDSnet.org/docshare/energy/20040428105917_OTEC_UN.pdf> [27th May 2009]
- (Anon), Celestopea gateway to a sustainable future. Ocean Thermal Energy Converter (OTEC) available from <<http://www.celestopea.com/OTEC.htm>> [2nd July 2009]
- Christopher, D., Barry, P.E., (2008) 'Ocean Thermal Energy Conversion and CO₂ Sequestration', Renewable Energy World.com 1st July 2008, available from <<http://www.renewableenergyworld.com/rea/news/article/2008/07/ocean-thermal-energy-conversion-and-CO2-sequestration-52762>> [7th December 2011]
- Cohen, R., (1982) 'Energy from the ocean.' Phil. Trans. R. Soc, A307, 405-437
- Crest, Flexible and distance learning series, Wave Power, Unit 9 (2004/05). Study notes for Hydropower, Loughborough University
- Enrick, M.R. and Scott, M.K. (1990) 'CO₂ solubility in water and brine under reservoir conditions', *Chemical Engineering communications*, 90(1), 23-33
- Falkowski P., G.,(1997). Evolution of the nitrogen cycle and its influence on the biological sequestration of CO₂ in the ocean. *Nature* (Letters to Nature), 387, 272-274
- Green, H.J. and Guenther, P.R., (1990) 'Carbon Di-Oxide release from OTEC cycles'. International conference on ocean energy recovery, Report -SERI/TP-253-3594; UC category: 262 DE 89009504, held 28-30th November 1989 at Hawaii
- Hammond, G and Jones, C., (2008) Data on LCA & EA [Communication from Dept of Mechanical Engineering, University of Bath, UK] available from <www.bath.ac.uk/mech-eng/sert/embodied> [1st August 2009]
- Heydt, G.T., (1993) 'An assessment of ocean thermal energy conversion as an advanced electric generation method', Proc. IIEE, 81(3), 409-418

- Huang, J.C., Krock, H.J. and Oney, S.K., (2003) An OTEC overview, 1-20 available from <<http://library.greenocean.org/oteclibrary/otecpapers/revisitedotec>>, [20th April 2007]
- Langton, R., Davies, I.M. and Scott, B.E., (2011) 'Seabird conservation and tidal stream and wave power generation: Information needs for predicting and managing potential impacts', *Marine Policy*, 35, 623-630.
- Link, H., (1989) 'Operational Experiences of the OC-OTEC experiments at NELH'. SERI/TP-253-3480, UC category:262, DE8900877, '11. Annual American Society of Mechanical Engineers solar energy conference' held 2-5th April 1989 at San Diego, CA (United States).
- Mathew, S., (2006) *Wind Energy: Fundamentals, resources analysis and economics*, Chapter 7. Berlin Heidelberg: springer, 209-231, available from <<http://www.albadr.org/www/pdf/library/495.pdf> > [13th December 2011]
- Nuttal L., J (1977) Conceptual design of large scale water electrolysis plant using solid polymer electrolyte technology. *International Journal of Hydrogen Energy* 2(4), 395-403
- Odeh, N. A., Cockerill, T.T., (2008) 'Life Cycle analysis of UK coal fired power plants', *Energy conversion and Management*, 49, 212-220
- Pitcher, G. C., Figueiras, F. G., Hickey, B. m., and Moita, m. T., (2010), 'The physical oceanography of upwelling systems and the development of harmful algal blooms'. *Progress in Oceanography* 85(1-2) 5-32.
- Quere, C.L., et al. (2005), 'Ecosystem dynamics based on plankton functional types for global ocean biogeochemistry models'. *Global Change Biology*, 11 (doi:10.1111/j.1365-2486.2005.01004.x), 2016-204.
- Ravindran, m., (1999) The Indian 1 MW floating OTEC plant-An overview, [Key note address], The international OTEC/DOWA conference, 31 Oct-2nd November 1999, Japan: Imari
- Roels, June. (1980). 'Food, Energy, and Fresh Water from the deep sea', *Mechanical Engineering*, 37
- Ryzin, J.V., Grandelli, P., Lipp, D. and Argall, R., (2005), 'The Hydrogen Economy 2050: OTEC Driven'. Proc. of MTS/IEEE, Oceans 2005
- Tahara, K., Kojima, T. and Inaba, A., (2000) ' Estimation of Ocean Thermal Energy Conversion System by using LCA Methodology'. *OTEC*, 8, 31-41 [In Japanese]
- Takahashi, M., (2000), 'Chapter 3 OTEC is not a dream'. In: *Deep ocean water as our next natural resource*. Tokyo: Terra Scientific publishing Co, 31-44

Takahashi, P., (2003) Energy from the sea: The Potential and Realities of Thermal Ocean Energy Conversion (OTEC.) [lecture], Anton Bruun Memorial lecture, 30th June 2003. Paris: UNESCO House, available from

<http://library.greenocean.org/oteclibrary/otecpapers/energy_from_the_sea.pdf> [1st June 2009]

Takahashi, P. and Trenka, A., (1996). *Ocean Thermal Energy Conversion*. John Wiley and sons, pp: 49-77

Vega, L. A., (1992) Economics of ocean thermal energy conversion (OTEC) in 'Chapter 7 of Ocean Energy Recovery: The State of the Art' Published in *Ocean Energy Recovery*, ASCE (1992), 152-181

Vega, L. A., (1999) 'Ocean Thermal Energy Conversion', *OTEC*, 1-22

Vega, L. A., (1995). 'Economics of Ocean Thermal Energy Conversion', USA: PICTER, Honolulu, available from
<www.seafriends.org.nz/oceano/seawater.htm> [1st July 2009]

Varley Robert (2013). Lockheed Martin MS2 New Venture, E-mail.
Communication with the 1st author, Dr. Subhashish Banerjee, in 2013)

Vega, L. A., (2002/2003a) 'Ocean Thermal Energy Conversion Primer'. *Marine Technology Society Journal*, 6(4), 25-35

Zolfagharifard, E., (2011) 'Solar Energy: Tropical Idea' *Engineer* (London), 26-27

The Lessons of Nature and Heat Pipe OTEC

*Jim Baird, freelance writer and inventor,
Canada*

If we observe Nature's lessons on dealing with warming oceans, we can produce the energy we need while moderating the impacts of climate change. Unfortunately, to date those lessons have gone, for the most part, unheeded.

Cost and a fear of environmental drawbacks have been the principal impediments to the advancement of OTEC. Plus the fact the environmental benefits that can be derived by building systems that replicate Nature's response to an overheating ocean have not been highlighted, let alone capitalized on.

Global warming is arguably the most compelling problem facing mankind and as this text shows it is mainly manifest by the accumulation of heat in the ocean. Over ninety percent of warming heat has ended up there; and on average 85 % of the ocean heat storage occurs above 750 meters of depth (Hansen et al., 2005). This natural stratification presents the conditions essential to producing work with a heat engine. Using the temperature difference between cold and warm water, the heart of OTEC is indeed a heat engine, producing electricity (and, in open cycle OTEC, fresh water). Due to its low thermodynamic efficiency, somewhere between 20 and 50 times more heat is moved to the deep compared to the work produced with an OTEC plant. This is another way of saying that the thermal efficiency of OTEC is about 3 %, or roughly a tenth of an automotive engine.

The hot source of the OTEC equation is readily available on or near the ocean's surface. The hard part is accessing the cold sink that lays 1,000 meters below the surface. To produce work one either has to move heat to the deep or bring cold water to the surface so that a working fluid can turn

to vapor, drive a turbine, and be condensed, time after time. The conventional approach to OTEC uses the latter technique.

The thermodynamic efficiency of a heat engine is dependent on the temperature differential between the hot source and cold heat sink. The greater the difference, the more efficient is the system. In the ocean that differential is small in absolute terms, so to maximize it one has to access the nearest source of cold water at a temperature of around 4 °C. In the oceans, that water is available at about 1,000 meters. At 4,500 meters, somewhat colder water can be accessed but it is impractical to try to obtain it in view of the small efficiency gain that would be achieved.

Conventional systems bring the 4-5 °C water to the surface to condense the working fluid vapor after it has passed through a turbine. The warmed water is then discharged back to a depth of about 70 meters. To get meaningful power out of such an OTEC system, massive volumes of water have to be moved; first to boil the working fluid in the vaporizer and then about half as much cold water is needed to service the condenser. As Luis Vega points out, approximately 4 m³/second of warm seawater and 2 m³/second of cold seawater (ratio of 2:1) with a nominal temperature difference of 20 °C are required per MW of net electricity produced for conventional OTEC designs (Vega, 2002/2003). To produce 100 MW of power with such a system, a 1,000 meter long cold water pipe of approximately 10 meters diameter is required (NOAA's Office of Ocean & Coastal Resource Management, 2010).

Pipes of this magnitude are costly as is the infrastructure required to support them. In addition, the movement of large volumes of water in these pipes can at ill-suited locations affect marine life.

Global warming heat accumulating in the oceans

Climate skeptics have seized on the leveling of the temperature trend of the past sixteen years as evidence that global warming has ground to a halt. As is evident from Levitus et al. (2012), the heat that hasn't been measured recently in the atmosphere – which accounts for only about 2.5 percent of the total global warming heat – has been found in deeper water. The authors point out that to a depth of 2,000 meters the oceans have warmed by an

average of 0.09 °C over the 55 year span of the group's study. Average surface temperatures over land and sea have increased almost four times as rapidly, or roughly 0.85 °C from 1880 to 2012, according to the Intergovernmental Panel on Climate Change (IPCC, 2013). The average depth of the oceans is 4,267 meters; therefore they have over twice the capacity to absorb heat as to the 2,000 meters Levitus measured.

Beyond doubt, the oceans play a major environmental role. Their top few meters store as much heat as the entire atmosphere. Because of their huge mass they can accumulate a great deal of heat without a significant elevation of temperature.

In a recent *Nature* interview (Ball, 2014), the independent scientist and father of the Gaia hypothesis James Lovelock was asked "Is climate change going to be less extreme than you previously thought?" Lovelock responded:

[W]e were all so taken in by the perfect correlation between temperature and CO₂ in the ice-core analyses [from the ice-sheets of Greenland and Antarctica, studied since the 1980s]. You could draw a straight line relating temperature and CO₂, and it was such a temptation for everyone to say, "Well, with CO₂ rising we can say in such and such a year it will be this hot." It was a mistake we all made.

We shouldn't have forgotten that the system has a lot of inertia and we're not going to shift it very quickly. The thing we've all forgotten is the heat storage of the ocean – it's a thousand times greater than the atmosphere and the surface. You can't change that very rapidly. (Ball, 2014)

Lovelock's point goes to the ocean's thermal inertia, and in retrospect it is hard to understand how this could have been missed by so many scientists.

Indicative of the kind of benefit we are deriving from ocean heat absorption, Levitus et al. (2012) points out, is that if the 0.09 °C the oceans have absorbed was instantly transferred to the lower 10 kilometers of the atmosphere, it would warm on average 36 °C. This would spell our demise and that of most other species, but fortunately this transference won't

happen all at once. Rather, just as the oceans are slow to warm, it will take a long time for them to cool by giving back the hypothetical 36 degrees to the atmosphere. It is currently believed it will take at least a thousand years for the oceans and the atmosphere to come back into equilibrium once we stop adding greenhouse gases to the atmosphere (Solomon et al., 2009).

Key amongst the eight climate risks identified by the IPCC in its latest report on climate change is death, injury, ill-health, and disrupted livelihoods in low-lying coastal zones and small island developing states and other small islands, due to storm surges, coastal flooding, and sea-level rise (IPCC, 2013). A few years back, the insurance company Allianz and the WWF put the value of coastal infrastructure at risk to these threats at USD 28 trillion by 2050 based on the elevations of sea levels by a half meter (Allianz & WWF, 2009).

Tropical storms – an increasing problem

Research published by the Niels Bohr Institute suggests there could be a tenfold increase in hurricane frequency if the climate becomes two degrees Celsius warmer (Grinsted et al., 2013). A “business as usual” approach makes this virtually a certainty, with increases of from 3.7 to 4.8 degrees a possibility. At the higher range, life on Earth would be fundamentally changed.

Typhoon Haiyan was a strident overture to the 2013 Warsaw Climate Change Conference that made limited progress on climate issues. Two of those issues have been around for much of the nineteen year long history of the IPCC; the control of carbon emissions and aid to poor countries so that they can control their emissions.

At Warsaw however, a new one emerged, a demand from countries like the Philippines for restitution from the developed nations for the “loss and damage” they suffer from climate change. The Philippines lead negotiator Yeb Saño opened the Warsaw conference by announcing he would fast until a loss and damage mechanism, which is now called the “Warsaw Mechanism”, was obtained. The Warsaw International Mechanism for Loss and Damage associated with Climate Change Impacts addresses loss and damage associated with impacts of climate change, including extreme events

and slow onset events, in developing countries that are particularly vulnerable to the adverse effects of climate change (United Nations, 2014).

With respect to carbon emissions, China and India which now rank first and fourth amongst the world's leading emitters (with the United States and European Union coming second and third) have refused to announce any specific reduction targets. Fundamental to their position is they are industrial newcomers. The bulk of the CO₂ in the atmosphere is the result of the developed world's massive use of fossil fuels to grow their economies, and so, China and India see no reason why their growth should be constrained in the absence of a realistic energy substitute.

The two countries have recruited other emerging nations to their position which places the United States and Europe in the untenable position of having to cut their emissions, pay poor countries to do the same and now potentially pay restitution without any guarantee that any of it will make any difference to the global pool of CO₂. It goes without saying that such a stalemate suits the agenda of the fossil fuel exporting nations.

The key to unraveling this conundrum is a realistic energy substitute that prevents most of the loss and damage from climate change, which forecloses the need for restitution, and fulfills the energy needs of the developed and emerging nations alike. Both the developing and industrialized world need to grow their economies using energy that mitigates the cause and effect of climate change.

Typhoons like Haiyan are Nature's response to overheating ocean surfaces, and are indicators of prime locations for ocean thermal energy conversion operations.

It is in China's, Africa's, and India's economic interest to find a realistic energy substitute that is close at hand and is increasing in availability, thus likely to decline in cost, as opposed to fossil fuels, which are depleting and becoming increasingly expensive. Significant OTEC operations in the Pacific could theoretically have moderated typhoon Haiyan, and at the same time provided much needed power to the region. Atlantic operations would moderate storms like Katrina and Sandy and could provide energy to the Americas, Europe, and Africa.

Cyclones (hurricanes or typhoons) and OTEC would compete for the same source of energy; the surface heat of the oceans. To the extent OTEC

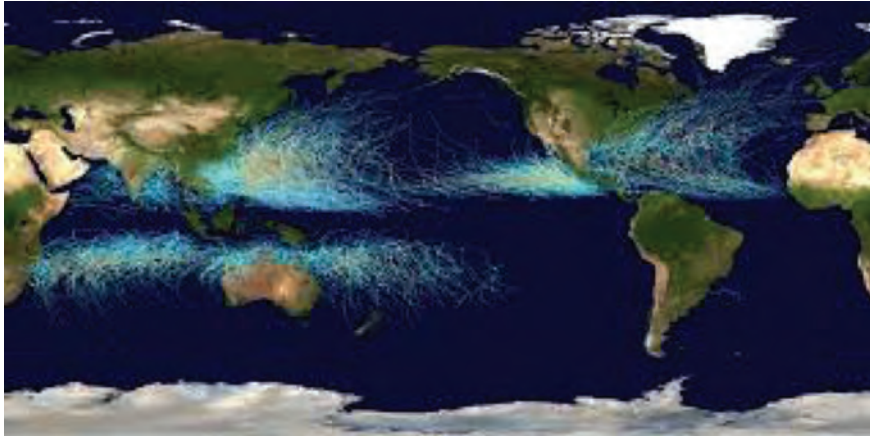

Figure 1. This map picturing cyclones from 1985 to 2005 shows how ocean surface heat as a source of energy is the most abundant and closest source of power to China, India and the east coast of Africa. Image retrieved from http://commons.wikimedia.org/wiki/File:Global_tropical_cyclone_tracks-edit2.jpg. Used with permission.

would draw off this heat it would no longer be available to power the cyclones. The preponderance of – and the strongest – cyclones occur in the northern hemisphere. They do not cross the equator. There is in fact a sweet spot at the equator where OTEC’s potential is the greatest and cyclones, which have destroyed most early OTEC efforts, are absent.

The equator is the socio-economic demarcation as well between the north and south. The more developed countries with the most expensive coastal infrastructures are typically in the north where they are at the greatest risk to storms and its destructive accomplice, sea level rise. About half of the increase in sea level rise to date is attributable to thermal expansion caused by the accumulation of the same heat that powers hurricanes.

The damage from hurricane Sandy in 2012 is estimated at \$68 billion coming on top of \$81 billion for hurricane Katrina in 2005 and \$19 billion for Irene in 2011. We are well on our way to meeting the Allianz/WWF projection of \$28 trillion in \$50 billion tranches.

Climate expert Joe Romm recently pointed out, in order of their scientific certainty, how global warming makes storms more destructive:

- ♦ sea level rise makes storm surges more destructive,

- ♦ higher sea surface temperatures (SSTs) increase atmospheric water vapor leading to more rainfall and flooding,
- ♦ increased water vapor and higher ocean temperatures are likely to make storms more intense and bigger, and
- ♦ warming extends the range of increased SSTs, which can help sustain the strength of a hurricane as it steers on a northerly track into cooler water (Romm, 2012).

Increased sea surface temperatures is the common denominator.

OTEC is a thermodynamic method for moving sea surface heat to the depths to produce energy in a heat engine. The most effective way to move this heat is the same way a hurricane does, with phase changes of liquid.

About 20 times as much surface heat as produced power is moved to the depths in the process. Paul Curto, former Chief Technologist with NASA, recently pointed out that OTEC's impact on reducing the sea surface temperature (SST) over time will be on the order of one degree F per decade at a power level of 2.5 terawatts (Curto, 2010).

Moving heat to the depths also decreases sea level rise because the coefficient of expansion of water is less at the reduced temperature, and converting heat to work in accordance with the First Law of Thermodynamics accomplishes the same thing.

SST running at over 3 °C above normal along the Atlantic coast from Florida to Canada was the driver for hurricane Sandy (Trenberth, 2012). Global warming is estimated to have contributed about 20 percent of this heat, which would not have been available had we been producing 2.5 terawatts of OTEC power the past 10 years.

Climatologist Kevin Trenberth points out that with every degree C, the water holding of the atmosphere goes up 7 %, and the moisture provides fuel for tropical storms (Trenberth, 2012). Five terawatts of OTEC power each decade would negate this increase. Hurricane season runs from June through November in the northern hemisphere and January to March in the south. Thus, in order to influence these storms it would be advisable to have OTEC grazing ships that could travel with the seasons to the areas where heat buildup is most intense, with a capacity to rapidly draw down this excess.

New view on energy and environment buys time

OTEC would mitigate many of the problems the world faces at once, by converting heat that causes thermal expansion to work, diminishing the power of storms that move heat to the poles, moving heat to regions of diminished coefficient of expansion, and converting ocean volumes to the energy currency and hydrogen gas that is necessary to move offshore generated power to market.

A recent study published in *Science* points out that the heat storage capacity of the oceans is far greater than previously expected (Rosenthal et al., 2013). Yair Rosenthal, a climate scientist at Rutgers University and the lead author of the study, says:

We may have underestimated the efficiency of the oceans as a storehouse for heat and energy. It may buy us some time – how much time, I don't really know. But it's not going to stop climate change. (Columbia University, 2013)

However, it will continue buying us time only if we see energy and the environment as a single issue. A wide-spread use of OTEC, and in particular of the heat pipe solution suggested below, has a number of positive features:

- In the long run it will be more productive for the developed countries to provide emerging nations with energy that mitigates the climate problem than to pay them reparations that will have limited remedial impact on their environment.
- OTEC can effectively air condition the planet by converting heat to work and moving exponentially more to the relative safety of deeper water. The use of a heat pipe replicates the conditions that precipitated the global warming hiatus, only more so: The trade winds move surface heat to depths of about 100 to 300 meters. OTEC using a heat pipe would triple this relocation; making it that much more difficult for the relegated heat to return.
- Flooding and sea level rise would be reduced by the relocation of heat to a region of reduced coefficient of thermal expansion.
- Moving heat away from the surface also saps the energy of tropical storms that bring with them the dual threats of wind and low pressure driven storm surge.

- ♦ Implemented on a massive scale OTEC would moderate atmospheric temperatures the same way the warming hiatus is believed to have been brought about by moving heat into the ocean deep, and in so doing marine and coastal ecosystems would benefit from the reduction in thermal stratification that cuts phytoplankton off from the nutrients they need to survive. Phytoplankton are the base of the ocean food chain and the lungs of the planet as they provide half of the oxygen we breathe by consuming CO₂ in the ocean.
- ♦ All use of fossil fuels can in theory be replaced by OTEC, which in turn mitigates sea level rise and storm surge, and effectively stops global warming.
- ♦ The design and build out of the infrastructure that could save coastal communities and island nations represent an enormous economic as well as social opportunity.
- ♦ There are also anticipated spin-offs from a transition to this remedial energy form, such as desalinated water or water reconstituted from hydrogen electrolyzed at sea to bring OTEC power to shore and, hypothetically, recovered dissolved mineral wealth from the oceans.
- ♦ OTEC is one of the best rationales for the “hydrogen economy”, i.e., a system where energy is delivered using hydrogen.

Because the link between ocean heat and global warming was missed thirty years ago and has only casually been made subsequently, the benefits of ocean thermal energy conversion have largely been overlooked at a critical juncture in the evolution of clean energy.

OTEC compared to other energy sources

OTEC was first proposed in 1881 by the French physicist and engineer Arsene d’Arsonval and all subsequent efforts have focused on the cold water pipe design, where cold deep sea water is pumped to the ocean surface. Often succeeding efforts have expanded on the lessons learned from previous failures, but so far, OTEC has not broken through commercially.

The recent IPCC Special Report on Renewable Energy Sources and Climate Change Mitigation found that taking into account the lifecycle of

various means of producing electricity, ocean energy was the second lowest generator of CO₂/kWh. Hydro was the best performer by this measure but has limited capacity, and hydro power can have severe environmental effects including flooding and large scale relocations of populations. Not surprisingly, oil and coal are the worst candidates when it comes to producing electricity. In this respect, ocean energy is an impressive 125 times better than coal. Of interest, ocean energy produces only half the emissions of nuclear power that is often touted as the best environmental option.

Indeed, it's a common belief that that nuclear power is the only practical alternative to coal for producing electricity. Lovelock's previous statement – "The thing we've all forgotten is the heat storage of the ocean" – however bears reconsideration. The journalist Karl Grossman once wrote that "nuclear power is a hell of a way to boil water". Boiling water is also a hell of a bad way to generate electricity. It produces twice as much heat as energy and most of that waste ends up in the ocean where it adds to the sea level and storm surge problems. OTEC on the other hand converts the heat already causing damage in the ocean to productive use and our environmental benefit.

OTEC and the heat pipe

In 1963 Los Alamos National Laboratory was working on the idea of using a nuclear reactor to generate electricity in space and Dr. George M. Grover came up with the first working heat pipe as a way to move heat out of the reactor efficiently.

Heat pipe engines are now what PCs, tablets, and smart phones use to dissipate unwanted and damaging heat. They are sometimes described as thermal superconductors because of the high heat transfer coefficients for boiling and condensing working fluids. They are highly efficient thermal conductors which move heat away from areas where it can do harm. Their efficiency stems from the movement of heat through phase changes of a working fluid, at speeds approaching that of sound, in the absence of any moving parts. The following is a diagram of a typical heat pipe engine.

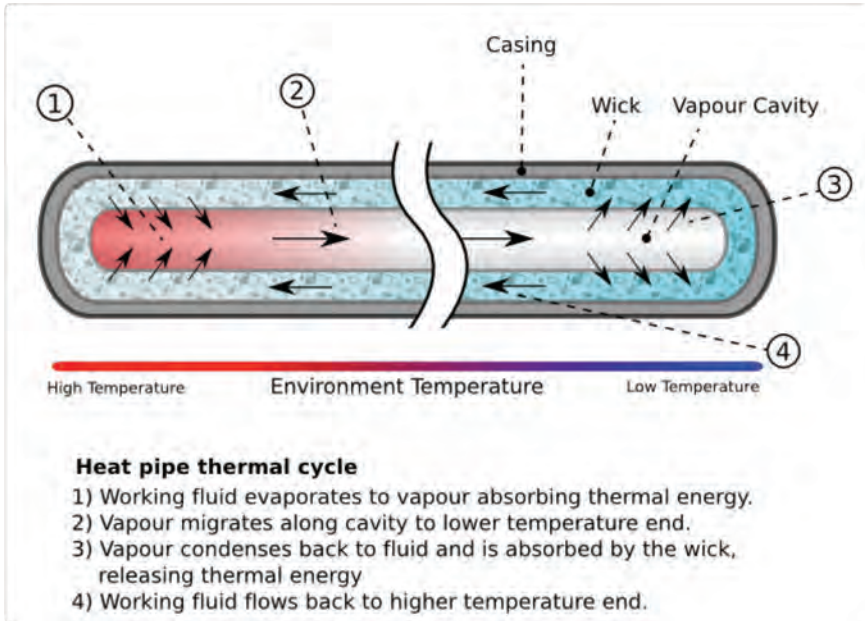

Figure 2. Principle of a heat pipe engine. Retrieved from http://commons.wikimedia.org/wiki/File:Heat_Pipe_Mechanism.png. Used with permission.

The energetics of a tropical cyclone may be idealized as an atmospheric Carnot heat engine, because large volumes of heat are being moved from the ocean's surface to the stratosphere through phase changes of water. Cyclones are effectively therefore atmospheric heat pipes and they are the most compelling example of how Nature deals with its overheating oceans.

The movement of surface ocean heat into deeper water in the western equatorial region of the Pacific, driven by stronger than average trade winds, is believed to be the reason for the atmospheric warming hiatus of the past sixteen years (Tollefson, 2014). By efficiently moving surface ocean heat into deeper water with a heat pipe, through a heat engine, we can produce as much energy as we currently derive from fossil fuels (Rajagopalan & Nihous, 2013) even as we moderate atmospheric temperatures, similar to how the atmospheric warming hiatus has been brought about. By inserting a turbine into the vapor stream of such a pipe, electricity can be produced the same way a conventional OTEC plant produces power.

The improvements of a heat pipe design over the conventional OTEC design are:

- The piping can be one order of magnitude smaller. Instead of the 10 meter diameter cold water pipe referred to above for a 100 MW plant using a cold water pipe, United States Patent Application 20070289303 of Melvin Prueitt uses a heat pipe, referred to in the application as a heat channel pipe, with an internal cross sectional area of just one square meter. The smaller pipes and supporting infrastructure lead to a commensurate decline in the cost of the system.
- The parasitic losses of the system are reduced because of the ability to move a greater volume of heat in a working fluid vapor rather than in water. (With the heat pipe, cold water doesn't move; the working fluid moves to the depths and is pumped back again.)
- The embodiment of James Lau's U.S. patent 8,484,972, July 16, 2013, requires no sea water movement with respect to either the evaporator or the condenser because the working fluid is sufficiently distributed within either heat exchanger to achieve a predetermined amount of heat energy transfer.
- Marine life is not impacted by the movement of vapor or the returning working fluid, which cycle in a closed system.
- CO₂ remains dissolved in sea water as no water is pumped up to the surface.
- Tropical cyclones require surface waters to a depth of 50 meters to be at least 26.5 °C before they can form. The heat pipe is the fastest way to remove heat approaching that threshold to deeper water away, or lessen the intensity of storms that have managed to form.
- A unit of heat at a depth of 1,000 meters produces less sea level rise than the same unit on the surface, because at depth the coefficient of expansion of sea water is half that of the tropical surface.

Instead of moving heat to the deep where this benefit is derived, conventional systems mix warm surface waters with the cold, thus cooling the higher coefficient of expansion water but with less sea level benefit. There is clearly a significant sea level benefit to be derived from cooling the ocean's surface by moving heat to deeper water.

The following is a rendering of a lab scale experiment that would test the heat pipe design.

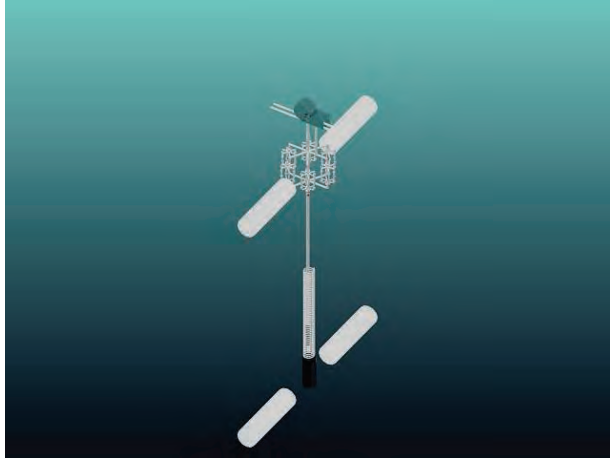

Figure 3. Rendering for testing of the heat pipe design. Figure by the author.

The experiment consists of two tanks stacked on top of each other, which have been stripped away in the rendering to make the system visible. The top tank replicates the surface temperatures in any of the world's oceans and the bottom represents the cold heat sink, which is between 4 and 5 degrees Celsius at a depth of 1000 meters in virtually any ocean. In such an experiment various working fluids can be tested and the effect on the warm and cold heat sinks with OTEC production can be measured.

OTEC using a heat pipe operates practically the same as a heat pump or automobile air conditioner:

1. A refrigerant is boiled in an evaporator, represented in the diagram by the array of six units in the upper tank.
2. The act of boiling the refrigerant absorbs a great deal of heat because the latent heat of evaporation of the fluid is high by comparison to its specific heat.
3. The vapor exits the evaporator and at that point it can drive a turbine attached to a generator. In the rendering the turbine is situated on the top of the upper tank.

4. The vapor then moves to a condenser where the heat is dissipated into a heat sink – the bottom coil in the rendering – and the vapor condenses.
5. The condensed working fluid is then pumped back to the evaporator to restart the cycle.

Moving on: Implementing Heat Pipe OTEC

There are three obvious questions that need to be answered with respect to the development of a new OTEC design that replicate Nature's response to climate change:

- ♦ Would it work?
- ♦ What would it cost?
- ♦ What are the alternatives?

These questions will be addressed in the following.

Would it work?

The thermodynamic principle of the heat engine is well established. It is the same principle that applies to heat pumps and refrigeration. As shown in this text, Nature operates on the same principle: Her response to overheating oceans is tropical cyclones that convert heat to mechanical energy and move heat to cooler regions of the planet.

The OTEC heat engine turns the tropical cyclone on its head: mechanical energy drives an electrical generator, and heat is moved to deep water rather than the stratosphere to condense the working fluid.

There are a number of patents and patent applications for various heat pipe designs. The perceived drawback to these designs is the crushing force at depth acting on a pipe containing a low pressure vapor: As the vapor condenses, the center of the vapor column is further depressurized at its maximum depth and the ocean's greatest pressure. It is thought the thickness of pipes needed to withstand this crushing force inhibits the thermodynamics required to condense the working fluid vapor.

The author's design counters the major drawback of the heat pipe by using a pressurized inner coil to strengthen the pipe. Cold water from the

deep flows through the coil at ambient pressure to facilitate condensation and equalizes the internal and exterior pressures acting on the pipe. The heat pipe at depth becomes effectively a coil condenser (see figure) whereas the entire 800 meters of pipe below the thermocline function as a Liebig condenser.

Before committing to the expense of a large ocean going prototype, the heat pipe design needs to be tested at lab scale.

What would it cost?

According to Dr. Luis Vega (Vega, 2010) the cost of OTEC produced electricity can be less than 0.18 \$/kWh, which is about midrange regarding national electricity prices (Wilson, 2012). Vega's calculations are based on a design using a cold water pipe. Due to the reduction in the size of the piping and supporting infrastructure, the heat pipe has the potential to shrink the capital cost of an OTEC plant by about 30 percent (Curto,

2010). Note that Vega's costs are for a first of kind. As shown with solar and wind, cost comes down rapidly with experience and economies of scale.

Admittedly, heat pipe OTEC has no proven track record and exactly how the efficiency of the design will differ from conventional OTEC plants is yet unknown. However, there are several things that speak for heat pipe OTEC over the conventional design:

- The thermal coefficient of expansion of ocean water at a depth of 1,000 meters is half that of the tropical surface. Thus sea level rise would be decreased by moving surface heat to the depths. (The movement of surface heat to deeper water replicates the conditions that have brought about the atmospheric warming hiatus.)



Figure 4. The inner workings of the heat pipe. Rendering by the author.

- ♦ There will continue to be water moving over the surfaces of the evaporators and the condenser. The benefit is that the hot water remains at the surface and the cold remains in the deep. The working fluid transfer the heat between them rather than diluting the surface heat with water brought from the depths.
- ♦ No running water also means less strain on the equipment.
- ♦ No movement of cold water from the depths to the surface means that heat pipe OTEC can be environmentally sound in places where conventional OTEC misses out.
- ♦ As the pipes are smaller in size, the heat pipe plant has an advantage when it comes to construction costs.
- ♦ As the design's "plant" is submerged, the horizon is not disturbed by a big structure. Thus, heat pipe OTEC can be used even in aesthetically delicate surroundings.
- ♦ If OTEC is used mainly to sap energy from the surface water, then a heat pipe design is most likely more economical than conventional OTEC.
- ♦ In addition, the efficiency of heat pipe OTEC can be improved by having pipes running through surface water horizontally (to maximize the uptake of heat, similar to ordinary geothermal heating) and by having proper insulation of the heat pipe itself, sending down as warm water as possible.

Future calculations and scaled-up tests are needed to see how the economics of heat pipe OTEC compare to conventional OTEC.

What are the alternatives?

As seen above, none of the other renewable energy sources are as multi-faceted as OTEC, and few of them can compare when it comes to CO₂ emissions. OTEC not only is a formidable energy source, but would also be an important addition to many developing countries. This text has tried to prove that a heat pipe design has several advantages over the currently used cold water pipe design. Put differently, heat pipe technology makes a good and impressively versatile technology even better.

Concluding remarks

Ocean heat storage is not without its ramifications. Sea level rise, increased storm frequency, and magnitude and prolonged impact of climate change are some of them. It would be in the environmental, and economic interest of coastal communities and island nations to take the lead in the development and installation of a technology that addresses both the cause – greenhouse gases in the atmosphere – and the effects – storm surge and sea level rise – of global warming.

OTEC, including forms such as Heat Pipe OTEC, would not only diminish storm surge and sea level rise, but is also the most effective and economical way to do so, as it produces marketable energy in the process.

*

Nature has much to teach us about how to produce energy and respond to climate change. One day, hopefully soon, we will heed her lessons.

Jim Baird is a freelance writer and inventor with international patents for nuclear waste disposal technology.

References

- Allianz & WWF, 2009. *Major Tipping Points in the Earth's Climate System and Consequences for the Insurance Sector*, Gland, Munich: Allianz & WWF.
- Ball, P., 2014. James Lovelock reflects on Gaia's legacy. Available at: <http://www.nature.com/news/james-lovelock-reflects-on-gaia-s-legacy-1.15017>. [2014-11-04].
- Columbia University, 2013. Is Global Heating Hiding Out in the Oceans?. Available at: <http://www.earthinstitute.columbia.edu/articles/view/3130> [2014-05-20].
- Curto, P., 2010. American Energy Policy V – Ocean Thermal Energy Conversion. Available at: <http://www.opednews.com/articles/2/American-Energy-Policy-V--by-Paul-from-Potomac-101214-315.html> [2014-05-24].
- Grinsted, A., Moore, J. & Jevrejeva, S., 2013. Projected Atlantic hurricane surge threat from rising temperatures. *PNAS*, 110, pp. 5369-5373.
- Hansen, J., L. Nazarenko, R. Ruedy, Mki. Sato, J. Willis, A. Del Genio, D. Koch, A. Lacis, K. Lo, S. Menon, T. Novakov, Ju. Perlwitz, G. Russell, G.A. Schmidt, and N. Tausnev, 2005: "Earth's energy imbalance: Confirmation and implications." *Science*, 308, 1431-1435.
- IPCC, 2013. Summary for Policymakers. In *Climate Change 2013: The Physical Science Basis. Contribution of Working Group I to the Fifth Assessment Report of the Intergovernmental Panel on Climate Change*. Cambridge, United Kingdom and New York, NY, USA: Cambridge University Press.
- Levitus, S. et al., 2012. World ocean heat content and thermosteric sea level change (0–2000 m), 1955–2010. *Geophysical Research Letters*, 39.
- NOAA's Office of Ocean & Coastal Resource Management, 2010. *Ocean Thermal Energy Conversion (OTEC) Technology*, Washington, DC. National Oceanic and Atmospheric Administration.
- Rajagopalan, K. & Nihous, G. C., 2013. An assessment of global Ocean Thermal Energy Conversion resources under broad geographical constraints. *Journal of Renewable Sustainable Energy*, 5, pp. 063124-1-063124-11.
- Romm, J., 2012. How Does Climate Change Make Superstorms Like Sandy More Destructive? Available at: <http://thinkprogress.org/climate/2012/10/31/1117091/how-does-climate-change-make-hurricanes-like-sandy-more-destructive/>
- Rosenthal, Y., Linsley, B. K., Oppo, D. W., Pacific Ocean Heat Content During the Past 10,000 Years, *Nature*, 342, November 1, 2013, pp. 617-621

Susan Solomon, Gian-Kasper Plattner, Reto Knutti, and Pierre Friedlingstein, 2009: “Irreversible climate change due to carbon dioxide emissions“. Available at: <http://www.pnas.org/content/106/6/1704.long>

United Nations Framework Convention on Climate Change, 2014. Warsaw International Mechanism for Loss and Damage associated with Climate Change Impacts.

Trenberth, K., 2012. Hurricane Sandy Mixes Super-Storm Conditions With Climate Change. Available at: <http://thinkprogress.org/climate/2012/10/29/1103711/trenberth-hurricane-sandy-mixes-super-storm-conditions-with-climate-change/>

Tollefson, J., 2014. Climate change: The case of the missing heat. *Nature*. Available at: <http://www.nature.com/news/climate-change-the-case-of-the-missing-heat-1.14525>

Vega, L., 2010. Economics of Ocean Thermal Energy Conversion (OTEC): An Update. *Offshore Technology Conference*.

Vega, L. A., 2002/2003. Ocean Thermal Energy Conversion Primer. *Marine Technology Society Journal*, 6(4), pp. 25-35.

Wilson, L., 2012. shrinkthatfootprint.com. Available at: <http://shrinkthatfootprint.com/average-electricity-prices-kwh> [2014-05-23].

The OTEC Africa Conference 2013

*Petter Dessne, founder OTEC Africa,
University of Borås, Sweden*

Introduction

For mankind as a whole, and in many respects, the world is becoming a better place each year. In both rich and poor countries the standard of living has improved steadily for a very long time. This progress has a serious drawback, the negative effect on the environment, even including the world's climate as a whole. The biggest problem concerns the use of energy, as fossil fuels increases the CO₂ content of the atmosphere, in turn melting large quantities of polar ice, increasing tropical storms, causing sea level rise, and seriously affecting also the coastal and inland climate.

We are now more than seven billion people, and several billions more are expected by the year 2050. We people of the industrialized countries over-consume the world's resources by about 200 %, meaning we would need three planets or so to fulfill our cravings. What will happen when all people of the developing countries – roughly 80-85 % of the world's total population – demand the same standard of living as we currently enjoy?

It is clear that the only way we can live sustainably is by consuming much less. However, as shown in studies such as (Moore & Rees 2013) this is not enough. In addition to abandon today's economic growth paradigm and replace it more important values, there is an undeniable need for new energy sources.

It's not only energy that is of major concern here. As the world's population grows, many countries will face even larger shortages of fresh, disease-free water and also of food. Most developing countries are situated in tropical regions and are therefore hit hard by tropical storms and similar weather-based disasters. In addition, each year, wars are fought for natural resources, and diseases are spread, often due to lack of clean water. At the

time of this writing, people are fleeing the wars in Syria, Iraq, and South-Sudan, and the Ebola virus threatens the world.

OTEC has been proved to be an ideal candidate for addressing and resolving problems related to shortage of electrical power and availability of fresh water for small island developing states (SIDS), and the EU has recently set aside 72 million for constructing OTEC plants outside Martinique. Built on a much larger scale, OTEC can, as the only technology known to man, in fact supply the world with its total energy and fresh water needs, increase seafood production many times over, and cooling off the sea surface when it becomes too hot, all this without any atmospheric emissions.

Pushing for this amazing technology is the reason why the aid and environmental organization OTEC Africa was founded, and, later, the OTEC Africa Conference 2013 was held.

Initiating the conference

In 2011 I started a position at the University of Borås, and being the founder of OTEC Africa, I discussed a possible OTEC Africa conference with the management. Luckily, the university was in the process of becoming the fifth Swedish ISO 14001 certified university. Together with OTEC researchers Linus Hammar (Sweden) and Said Ibrahim (Tanzania) I gave a presentation for the university's scientific board (the "Professors' colleague") in January 2012, demonstrating how a conference on OTEC could link the various facets on sustainability with talks on aid and technology (see figure below). The dean at the School of Business and IT, which is where I was positioned at the time, saw an opportunity to build a conference on economic sustainability, which led to the initial planning of the conference.

Sometime during fall 2012, Dr. Ted Johnson, who I had been chasing for several years, had found our web site and accepted to be the keynote speaker if a conference could be arranged, even though we wouldn't be able to reimburse him (or anybody else attending the conference for that matter) for his travels, food, or even the conference fee.

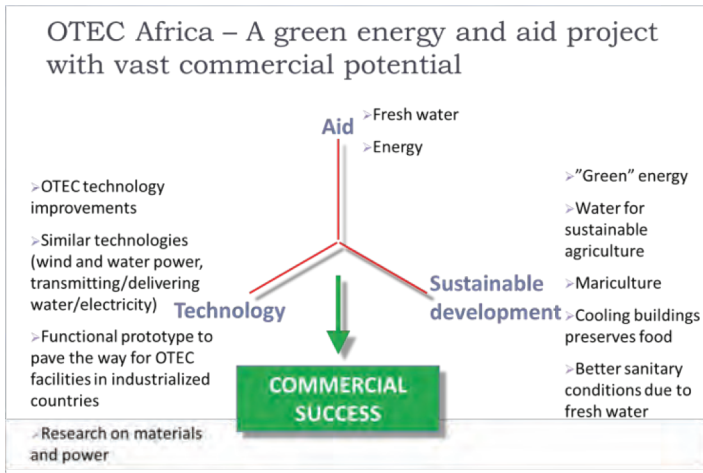

Figure 1. The idea behind OTEC Africa and the conference. Slide from the presentation for the Professors' colleague at the University of Borås, 2012.

During spring 2013, Dr. Lars Golmen joined as co-organizer, and Dr. Linus Hammar played a vital part in the planning process. It was decided that the conference should run lunch to lunch 15-16 October the same year, not to collide with the start of the semester or with winter holidays. The goal of the conference was to let OTEC researchers and people from the energy or sustainability research areas exchange ideas and meet with organizations that offer funding and advice on humanitarian matters. The plan was to keep the conference short and rather informal, to keep a highly efficient time schedule, and to put an emphasis on enabling connections.

This report provides a very brief summary of the conference's presentations, and also includes some reflections of the conference and on how similar gatherings can be run in the future.

The beginning of the event

After successfully having engaged some of the OTEC community's most renowned OTEC people as keynote speakers, more and more people expressed their interest in the conference and we ended up with about 20 speakers (some online) from 11 countries – probably some kind of efficiency record for a cleantech conference running for only a dozen hours.

I believe that there was a reason why we were so successful getting speakers to the conference, in a country where OTEC isn't even working and in a city where rain is abundant. We were simply just right in time – the oil price has gone up and people of today realize that the future for developing countries must be sustainable.

The web statistics from otecafrica.org told a success story as well: Between spring and October 2013, there were over 2,200 unique visitors, staying on the web site for an average time of an impressive four minutes. This indicates that the web site visitors were really absorbing the information we had put on display, meaning that there was indeed an interested target audience.

The day before the conference started the press started to call, and I and Lars Golmen were interviewed by Swedish television. We were also interviewed by Swedish newspapers and the radio. Thus, the number of speakers, the high interest from the web site visitors, and a surprisingly good media coverage proved that when the two-day conference started on October 15, the event was already a success.

The presentations

Many of the presentations at the conference were given by leading OTEC experts, and the lineup for the conference's technical track looked like a who's who in OTEC. Another track consisted of sustainable development in developing countries. Yet another track concerned how the Scandinavian industry and governments could be of assistance and provide business opportunities to the OTEC community.

In addition, the two OTEC-promoting organizations, OTEC Africa and OTEC Foundation, presented their work, and the vice-chancellor of the University of Borås told about the university's work on sustainability.

Needless to say, many of the presentations covered at least two of the tracks, but below follows a report from the conference, roughly divided in these tracks.

Track 1: OTEC and similar technologies

- Keynote speech: Ted Johnson, Ph.D., Executive Director and Head of OTEC Programs, Ocean Thermal Energy plc, USA: “OTEC in Africa and the Commercialization and Financing of OTEC”
- Sami Mutair, Ph.D., OTEC and desalination expert, Institute of Ocean Energy, Saga University, Japan: “Keynote speech: The future of OTEC”
- Hyeon-Ju Kim, Ph.D., Principal Research Scientist, Head of the Deep Ocean Water Application Research Center, Korea Institute of Ocean Science and Technology, South Korea: “What is OTEC? Expansion of OTEC objectives”
- Martin G. Brown, Consultant Naval Architect, GL Noble Denton, United Kingdom: “Floating liquefied natural gas (FLNG) platforms as a stepping stone to OTEC”
- Lars Golmen, Ph.D., Runde Environmental Centre and NIVA, Norway: “The TROPOS Project”
- Frederic Chino, Ocean Thermal Energy Conversion Sales & Marketing Manager, DCNS Ocean Energy Business Unit, France: “The DCNS roadmap on OTEC”
- Harold Lever, Ph.D., Archimedes Solutions, The Netherlands: “OTEC by SCHEG: Ocean thermal energy conversion by a subsea cycle of hydrofall energy generation, a new concept for medium scale OTEC”
- Pat Grandelli, M.Sc., P.E., Makai, Hawaii (via link): “OTEC Heat Exchangers: designs currently being tested at Makai’s OTEC Test Facility” and “Biochemical simulation for the environmental effects of the discharge water from a 100 MW OTEC plant”
- CB Panchal, Ph.D., Consultant, President at E3Tec Service, LLC, USA (via link): “Production of fresh water using ocean thermal energy”
- Vincenzo Palermo, Ph.D., National Research Council, Italy (via link): “Ongoing research for creating graphene-based composites for heat exchangers, to be used at sea, to replace copper and steel exchangers”

- ♦ Bengt-Olof Petersen, Director, Lighthouse Maritime Competence Centre, Sweden: “The challenge to meet the zero vision of shipping”

Listed as speakers were also Drs. Luis Vega and Lawrence Awosika, but due to technical problems they were unfortunately unable to give their presentations.

It is probably not an exaggeration to say that this was the most qualified gathering of OTEC people in recent history, and also most likely the reason why more and more people decided to attend the conference as the other names were added to the list of speakers. In retrospect, it's clear we should have performed a test run with the speakers by link as several speakers were not used to the online setup, but time simply did not permit this.

Many of the speakers presented new ideas and their latest achievements in OTEC technology (and one thing that sets the OTEC community apart from many other technology heavy businesses is really the willingness to share results). Frederic Chino, Pat Grandelli, and Tim Hogan particularly presented the latest findings of their respective companies (DCNS, Makai, and Alden Labs) as can be seen below. Lars Golmen presented the TROPOS project (see separate article in this publication).

Makai's current work on technology and environmental impact studies

Makai has been a contractor for dozens of unique research and development contracts concerning OTEC. Most recently, Makai has been involved with Lockheed Martin and others pursuing the development of 100 MW OTEC plants for island communities like Hawaii and Guam. Pat Grandelli is a lead engineer in Makai's OTEC division. In his speech, he described the progress on the company's work on heat exchangers (the heart of the OTEC process). He also discussed their latest findings concerning environmental effects from the outlet water of the designed plants.

The current advancements of DCNS

Frederic Chino is the OTEC Sales and Marketing Manager at DCNS, a company that this summer announced receiving the lion part of a 72 million euros order from the EU for constructing an OTEC plant outside the

Martinique island. This may well be the commercial breakthrough that the OTEC community has waited for, and needless to say, community members are very excited about it. At the conference, Mr. Chino presented the current work of the DCNS, and showed an educating as well as entertaining animated promotional movie for the Martinique project¹.

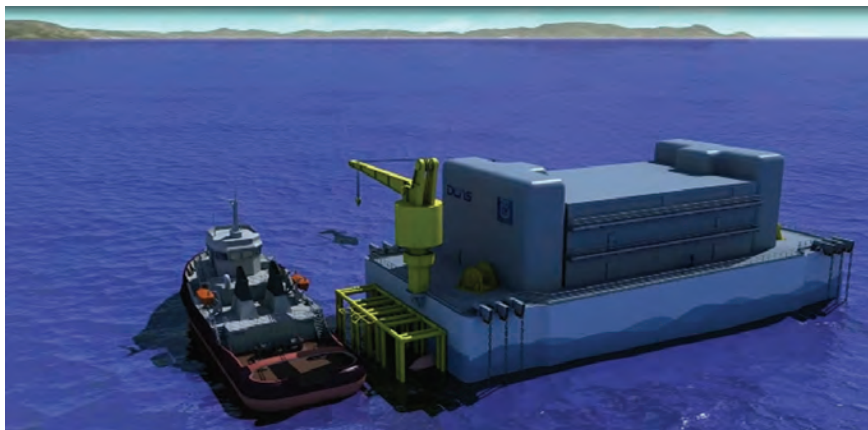

Figure 2. A frame from the animated promotional movie by DCNS of a proposed 16 MW OTEC plant outside the Caribbean island Martinique. Note the size of the plant, compared to the ship or the helicopter's shadow. Used with permission.

New takes on OTEC

Other speakers addressed new ideas in their field. CB Panchal and Harold Lever both discussed new ways to use OTEC. CB Panchal proposed new ideas for fresh water production using OTEC, and Harold Lever proposed a new methodology – SHEG – for developing small scale OTEC plants.

CB Panchal's work is presented elsewhere in this volume, and an article covering Harold Lever's ideas is scheduled for the next volume of *OTEC Matters*.

¹ The film can be viewed at this link: <http://en.dcnsgroup.com/energy/marine-renewable-energy/ocean-thermal-energy/>

Graphene – a welcome material in corrosive environments

Dr. Vincenzo Palermo introduced the audience to graphene and using graphene in a corrosive environment, and approached OTEC that way. Dr. Palermo is the leader of the “Functional Organic Materials” research unit of the National Research Council of Italy (CNR), and is one of the initial proposers of the GRAPHENE FLAGSHIP European initiative. He spoke of the institute’s research on graphene for coating, for use in heat exchangers and corrosive environments. In truth, graphene seems like the perfect solution for future OTEC projects, as the durability of OTEC plants will be multiplied.

The EU’s billion-euro investment in graphene will be headquartered in Gothenburg, Sweden, not far from Borås.

Martin Brown proposing FLNG production

To pave the way for OTEC, OTEC veteran Martin Brown from Noble Denton (now a part of DNV-GL), Aberdeen, suggested FLNG (floating liquefied natural gas) production as a natural step towards making large-scale OTEC coming true. Liquefied natural gas (LNG) has received a lot of attention in recent years for its environmental advantages over conventional fossil fuels. However, cooling the natural gas to liquid form is energy-intensive. Using cold deep sea water would lower the cost for accomplishing this. As deep sea water pumping is a trademark of OTEC plants, this is something that is of commercial interest even today, and at the same time this would promote the use of OTEC plants.

In addition to speaking of this novel and commercially interesting idea, Mr. Brown presented the audience with fascinating footage from the early days of OTEC.

Lighthouse and the Zero Vision of Shipping

Not specifically addressing OTEC technology, Bengt-Olof Petersen, the director of the Lighthouse Maritime Competence Centre, spoke of the research center’s unique approach to reach the Zero Vision of Shipping. The Zero Vision aims to provide competitive transport solutions while at the same time avoiding accidents as well as harmful emissions for the sea and

air. The corresponding Zero Vision Tool is a collaboration method and project platform for a more safe, environmentally and energy efficient transport by sea and also an organization where the maritime industry, academy, agencies, and administrations can meet to share experiences and find common, workable and effective solutions (Petersen 2013).

Petersen’s speech connected to Martin Brown’s idea on FLNG in that Lighthouse proposes FLNG as an alternate fuel for shipping, much because of its low sulfur content (Petersen 2013). If OTEC is used for the production of various gases instead of electrical power, Lighthouse and the Zero Vision concept can speed the spreading of the technology, as well as provide solutions for making transportations of OTEC products safer.

Keynote speech: Ted Johnson, OTE Corporation

In his keynote speech, Dr. Ted Johnson gave an excellent introduction to OTEC, to the history of OTEC, and to the current and future possibilities

Table 1. Projected water data and power generation for OTEC plants outside Nigeria and Zanzibar. The scale of the numbers give an indication of how much water is used in the OTEC process, and also of the amount of generated power needed for running the process (pumps etc.). With a gap of about 40 % between gross and net power, there is also room for improvement as the technology is developed further. Data from Ted Johnson’s keynote speech (Johnson 2013).

Water data	Nigeria	Zanzibar
Warm water inlet/outlet temperature, °C	27.5/23.1	27.5/23.4
Cold water inlet/outlet temperature, °C	5.5 / 13.1	7.0 / 14
Warm water flow, kg/s	33,416	42,350
Cold water flow, kg/s	19,620*	23,593*
Power generation, kW		
Gross power	17,759	19,504
Parasitic power	6,021	7,642
I&C, chlorinator, line losses	721	727
Net, kW	11,017*	11,134*

* Although Delta-T for Nigeria is greater than that for Zanzibar, net power is comparable for both sites due to pressured drop limitation of HDPE pipes that limits flow rate of cold water for the Nigeria plant with longer cold water pipe as compared to the plant at Zanzibar site.

of the technology. His history with OTEC and OTEC technology goes back twenty-five years and in 2009 he received the Ocean Energy Pioneer Award from the Ocean Energy Council for his achievements in OTEC. Having held a position as the Director of Alternative Energy Development at Lockheed Martin, Dr. Johnson now works as the Executive Director for OTE Corporation. Needless to say, his extensive background in OTEC research and commercialization was an interesting start to the conference.

OTE Corp. works in several African countries today. Two of their proposed areas for OTEC plants are Lagos in Nigeria and the island Zanzibar. The figure below shows a comparison between two projected plants for these parts of the western and eastern African coastlines.

Dr. Johnson also introduced the audience to the special needs of the African continent, stating that

- ♦ Africa has now over 500 million people
- ♦ The birthrate is the highest of any continent. By 2050, the population is expected to reach two billion
- ♦ By the year 2030, water and energy needs in the world are estimated to increase about 50 %. African nations represent a large part of this increase
- ♦ Every eighth second, a child dies due to contaminated water
- ♦ As this is the fastest growing region on the planet, it has great potential for OTEC. (Johnson 2013)

Keynote speech: Research and industry connections at Saga University

Several if not most of the speakers presented their current work. Dr. Sami Mutair, a specialist on OTEC and desalination using OTEC at Saga University, was one of them. In a jointly written presentation between himself and Dr. Yasuyuki Ikegami, he presented quite a few projects where Saga University was involved. He first noted that OTEC has several promising characteristics, in that it is an energy source...

- ♦ that is clean and renewable – OTEC uses only seawater as energy resource
- ♦ that is inexhaustible and applicable in 98 countries in the world

- ♦ that gives energy at a constant rate, day and night throughout the year
- ♦ of zero emission: no CO₂ or other greenhouse gases, and no SO_x, NO_x or any other waste compounds are produced. (Ikegami & Mutair 2013)

According to Dr. Mutair, the New Energy and industrial technology Development Organization (NEDO) of Japan have calculated that by 2020, 10 MW OTEC plants will be built for the Japanese market and the commercialization phase start. By 2030, they expect to see 50 MW plants and wide implementation in the international markets.

The presentation also reported on a new OTEC plant being built on the tiny Kume island south of mainland Japan. The island lies in the Okinawa district, and the district currently depends on fossil fuel for a staggering 99.8% of its energy consumption. Therefore, a higher degree of self-sufficiency of energy and also diversification of energy sources are necessary. Thus, Okinawa is implementing an OTEC demonstration project together with Saga University, with the goal of large-size plants and this should be a step towards commercializing OTEC. The project is scheduled to be evaluated after the first quarter of 2015.

Dr. Mutair also announced that Japan Marine United Corporation (JMU) had just a month before the conference got its Approval in Principle for a submersible 10 MW OTEC plant. Being submerged means a stable platform not subject to movement from tropical storms. Saga University and JMU have co-designed the plant.

Finally, he emphasized that though his presentation had focused on production of electrical power, secondary applications of OTEC plants play a major role on the economics of the technology, and “that of particular significance today is desalination and air conditioning” (Ikegami & Mutair 2013).

OTEC in South Korea

Some of the speakers pointed towards new paths for the future. One of these was Dr. Hyeon-Ju Kim, the leader of the Deep Ocean Water Application Research Center (DOWARC) at KIOST, South Korea. DOWARC, built

between 2008 and 2012, is a large research center for various aspects of research on deep ocean water, one of them being OTEC. At DOWARC research is also carried out on how organisms can be entrained in DOW applications.

Dr. Hyeon-Ju Kim estimates that before 2030, 50-100 MW OTEC plants can be built and used by populations over 50,000 (Hyeon-Ju 2013). He emphasized that the textbook meaning of OTEC – using the ocean temperature differences to produce electricity – must change, as so many countries, be they industrialized or developing, need other help from OTEC, such as fresh water and support for aquaculture.

As part of his presentation, an impressive film was shown on the design concept of a 100 MW submerged OTEC plant, named Kordi.

Research in Nigeria and Hawaii

As said above, Drs. Luis Vega (head of the research at USDOE National Marine Renewable Energy Center at the University of Hawaii) and Lawrence Awosika (head of the research at the Nigerian Institute for Oceanography and Marine Research, NIOMR) both had to cancel their appearances at the conference. To make matters worse, they were not able to provide online presentations due to technical problems. Luckily, Dr. Awosika sent his set of presentation slides to the conference, and so, there does exist some interesting material from NIOMR (by Dr. Awosika and Dr. David A. Aderibigbe). The authors state that Nigeria, with a population of over 150 million, satisfies the four requirements that they consider necessary for favorable OTEC sites:

- ♦ high thermal differences between the warm surface and the cold deep water
- ♦ low velocity water currents
- ♦ low frequency and severity of storms, hurricanes, and typhoons
- ♦ proximity to the market for OTEC products. (Aderibigbe & Awosika 2013)

For anyone familiar with OTEC advancements and its research community in particular, it comes as no surprise that the OTEC research of the University of Hawaii is highly ranked, and the works of Dr. Vega and

other Hawaiian researchers are frequently cited in this publication. Though a much smaller academic institution, NIOMR is of great importance to West Africa and also other regions. In fact, the reason why Dr. Awosika was unable to attend the event in person was that he currently chaired the UN Continental Shelf Commission. Further, Nigeria was recently elected the twentieth executive member nation of the Ocean Energy Systems Implementing Agreement (OES), an intergovernmental cooperation operating under a framework established by the International Energy Agency (IEA).

We hope to introduce the exciting and respected OTEC research at the Hawaiian and Nigerian universities in the next volume of *OTEC Matters*.

Track 2: Funding of cleantech and cleantech investments

- Per-Anders Widell, Head of Section, The Swedish Government, Sweden: “Swedish cleantech export and international aid: The Government’s strategy for the development of the cleantech sector”
- His excellency Dr. Joseph K. Sang, The Kenyan ambassador, Kenya: “Kenya – a nation of possibilities”
- Rémi Gruet, Director, Ocean Energy Europe, Belgium (via link): “The European Ocean Energy Association, OTEC, and the EU”

The Swedish Government and the Cleantech Strategy

Sweden is currently ranked as the world’s fourth best country on cleantech innovation (WWF 2014), and is among the world’s biggest contributors per capita and per income of the nation to international aid (OECD 2013). The Swedish government aims (just like OTEC Africa) to combine these two good things, and has therefore allocated many million euros for cleantech export opportunities. For this reason, Mr. Widell, who works for the Ministry of Enterprise, Energy and Communications, presented the Swedish government’s view on cleantech export. He also presented the Government’s Cleantech Strategy, with the goal to:

1. support the cleantech companies so that they can expand from an early to an mature phase

2. help Swedish cleantech companies explore possibilities in other markets
3. identify challenges Swedish cleantech companies are facing, with the ambition to reduce this barriers to expansion (Widell 2013).

Financially, the Cleantech Strategy resulted in a total of 46 million euros allocated to new initiatives including research/innovation, commercialization, and internationalization. The initiative was in addition to already ongoing activities to support the development of environmental technology (Widell 2013).

The major player in Sweden when it comes to international aid is Sida, which handles most of the Swedish aid funds. Though Sida was not represented at the conference, OTEC Africa is sometimes in contact with Sida officials. Sida was also behind a grant adding up to USD 25 million for securing the access to potable water in developing countries, together with USAid. A number of participants at the conference put together an application for this grant, and thoughts on applying for grants concerning OTEC as a tool for developing countries are planned for publishing in the next volume of the publication.

Kenya – a rapidly growing nation

Several of the presentations centered on suitable places for OTEC operations. The Kenyan ambassador showed how Kenya is a suitable country for OTEC technology. The nation is rapidly becoming industrialized with a yearly GNP growth of about 5 %, and the infrastructure has an increasing demand for fresh water and electricity. The ambassador gave an overview of the infrastructure of Kenya and provided examples of how access to electricity and fresh water could benefit its future development as a sustainable nation.

In 2007, the country launched the Vision 2030 program, which “aims to transform Kenya into a globally competitive and prosperous country and high quality of life by 2030” (Sang 2013). In order to achieve a high set goal of development, the government has acknowledged the need for a steady source of energy as a prerequisite, and OTEC seems like a promising technology, especially as it also produces fresh water. (A paper in part based

on the speech of the ambassador is scheduled for the next volume of *OTEC Matters*.)

The EU-OEA – of vital importance to the OTEC community

Dr. Rémi Gruet, the newly appointed director of the EU-OEA, provided an overview of the work of the association for enhancing the marine renewable energy and more particularly OTEC in front of the EU institutions. He also mentioned a study the EU-OEA was making at the time on the worldwide developments of OTEC, and presented the perception of this sector in the European institutions.

2013 was a critical year in the European decision-making calendar. By the end of the year the spending priorities for the Commission and the European Investment Bank were to be finalized for the next seven years. For the first time in twenty years, the Commission is actively considering taking a formal policy position to promote the commercialization of the ocean energy sector. The association's challenge is to transform these opportunities into real benefits.

It goes without saying that this can translate into funding to the OTEC community members, so the EU-OEA is an important actor to all of us interested in OTEC. Hopefully, the EU's initiative to sponsor the OTEC plant at Martinique is just the beginning.

Track 3: Aid/sustainability

The other major track for the conference involved sustainable aid to developing countries, with an emphasis on both ecological and humanitarian aspects: how can the African people and people in other developing regions benefit the most from water plus electricity from OTEC facilities? The track comprised of the following presentations:

- Björn Brorström, Ph.D., Vice-Chancellor, University of Borås, Sweden: “Welcoming address: A university for a sustainable future”
- Pär Carlsson, Strategic Development Coordinator, Borås Energy and Environment, Sweden: “Towards building sustainable and resilient cities – in Sweden and internationally”

- Nazdaneh Yarahmadi, Ph.D., Senior Scientist, Polymer Technology, SP Technical Research Institute of Sweden, Sweden: “SP and the Water Technology Centre”
- Linus Hammar., Ph.D., Department of Energy and Environment, Chalmers University, Sweden: “OTEC – Suitable sites and challenges for the coastal environment”
- Tim Hogan, Senior Fisheries Biologist, Alden Research Laboratory, USA (via link): “OTEC warm water intake design and potential environmental impacts”
- Zahra Yadali Jamaloei, Vekalat Magazine/Shiraz University, Iran: “OTEC technology for aiding women in developing countries: An investigation of women’s health-related quality of life in rural areas of Iran near the coast of Persian Gulf and Gulf of Oman”
- Hanna Sand Lindskog, Development manager, Environmental issues, City of Gothenburg, Sweden: “Who’s in power of hydropower? The access to electricity and participation in small scale hydropower projects in rural Tanzania and similar countries”

The University of Borås – a voice for sustainability

Björn Brorström, a professor in economics, is the vice-chancellor of the University of Borås. He has been central in the university’s recent move towards a sustainability profile, and welcomes proposals for joint research on sustainability. Quite naturally, his welcoming address focused on the university’s environmental agenda and also on the possibilities of cooperating with the university. As can be seen in the photo below, Borås is embedded in nature.

One of the recent projects that the university is involved in is a unique collaboration for establishing a new district of Borås, sustainable in both ecological and social aspects. The university of Borås is now, together with Gothenburg University, top-ranked in Sweden for its sustainability efforts, and its sustainability work is headed by the Sustainability coordinator Birgitta Pahlsson.



Figure 3. The University of Borås (the white and the brick buildings directly behind the tall chimney), seen from the rooftop of the new accumulator tank of the city. Photo by the author.

OTEC sites and ecological risks

Linus Hammar has worked with exploring the possibilities of OTEC for several years. He has spent a lot of time doing research in Tanzania, Mozambique, and other countries, looking for good sites for OTEC plants. Dr. Hammar wrote both his licentiate and doctoral theses on the implementation of OTEC and similar technologies in developing countries. Directly targeting the needs of the African people and the suitability for OTEC plants, his research is very close to the intention of OTEC Africa and the conference, and his slides of available OTEC resources in East Africa caught a lot of interest.

One of Dr. Hammar's main interests concerns environmental risks, and so, his presentation is connected to the presentation and the work of Tim Hogan (see below), who focused on environmental issues such as entrainment of fish and mammals in the large OTEC pipes. Although not new to the community, environmental concerns are high on the agenda for OTEC research, especially as this is a technology used for its environmental benefits.

Entrainment research at Alden Labs

Tim Hogan is a senior fisheries biologist at Alden Labs, with ten years of experience with various aspects of biological issues related to water intakes. His speech centered around his current research on entrainment of fishes in water intakes (such as the pipes used in OTEC). In addition, he presented a field ichthyoplankton entrainment sampling for a proposed OTEC plant in Kauai.

Together with OTE Corporation and Tenera Environmental, Alden Labs recently put together a report on potential environmental impacts from a planned Hawaii-based OTEC plant (Port Allen, Kauai)².

According to Mr. Hogan's presentation, the implications the study has for OTEC are that:

1. offshore intake location may pose less of an entrainment risk than onshore
2. there was no conclusive evidence of depth differences at depths sampled
3. construction of offshore intake pipeline would be more expensive and impactful to benthos than onshore
4. morphometric data can be used to optimize screen mesh sizes for intake

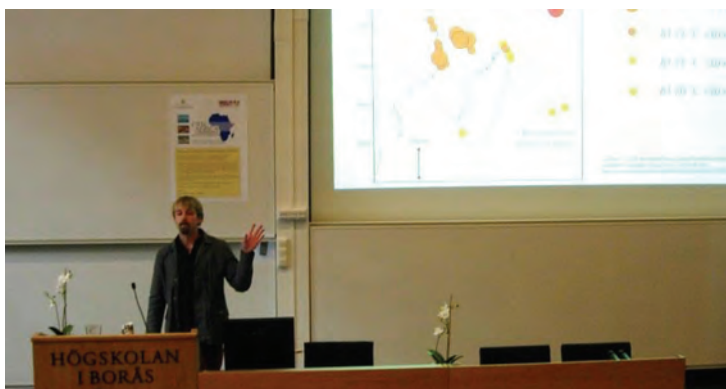

Figure 4. Dr. Linus Hammar presenting some suitable locations for OTEC sites. Photo by the author.

² This report is available at: <http://www.osti.gov/scitech/biblio/1092416>.

5. intake selected will have to balance environmental impacts with economic and operational feasibility. (Hogan 2013)

OTEC's role in a societal context

In addition to being placed in the appropriate locations according to ecosystems, sea surface temperature, and bathymetry, it is certainly vital that the OTEC plants are situated where they can help the most. The size of the plants must correspond to the size of the populations relatively close to shore, and the water and electricity that OTEC plants generate must reach the people who need it the most. Generally, in developing countries, this means women in families, who need fresh and disease-free water for household activities.

In her speech, Zahra Yadali Jamaloei discussed this very issue, pointing to areas where OTEC can be of help to women in rural locations in Persian/Arabic countries. (Her thoughts are presented in a paper elsewhere in this publication.)

Also Hanna Sand Lindskog discussed the potential role of OTEC (and other technologies) for individuals in rural locations. Prior to her work for the City of Gothenburg, she worked in Tanzania for the STEEP-RES project, a collaborated project between the City of Gothenburg and the Chalmers University of Technology. In Tanzania she studied small scale



Figure 5. Zahra Yadali Jamaloei giving her presentation on water and gender issues. Photo by the author.

hydropower projects from a social perspective, and though her speech focused on this matter, she also spoke of OTEC and the need for fresh water from a wider perspective.

The Borås perspective on aid and sustainability

Not only The City of Gothenburg but also several institutions in Borås are deeply involved with creating a sustainable development in developing countries. Pär Carlsson, Strategic Development Coordinator at Borås Energy and Environment, presented the city-owned company's work and competences, including district heating, district cooling, biogas, waste management, water and sewage treatment, and energy and waste services. In Borås, the company also produces electricity in a combined heat and power plant and in hydro power stations. Through research, development, international collaboration, and education, the company aims to be the driving force in developing a sustainable city. Borås Energy and Environment works actively with communities in Indonesia and in Brazil. Three years ago, a biogas plant was successfully installed in Indonesia with aid from the city-owned companies (Andréasson 2011).

By using a unique recycling model the company converts the energy of the city's waste streams into renewable valuables, with the hope of creating a city free from fossil fuels. For example, all households in Borås get two sets of waste bags, white for burnable and black for organic waste. The burnable waste bags are burned and used for heating private and official buildings, and the organic waste bags are converted into biogas, used by the local buses and other vehicles. The figure below demonstrates the recycling process of the company.

Dr. Yarahmadi set out to present the work at the Water Technology Centre at the SP Technical Research Institute of Sweden. The governmental company works on many areas related to technology, and at the Water Technology Centre research is being done on water purification, collection of storm water, wastewater treatment systems, durability of plastic pipes for fresh water transport, and more (see figure below). The work at SP is to a high degree project-based, and for the Water Technology Centre, many projects deal with water issues from a systems perspective – how should

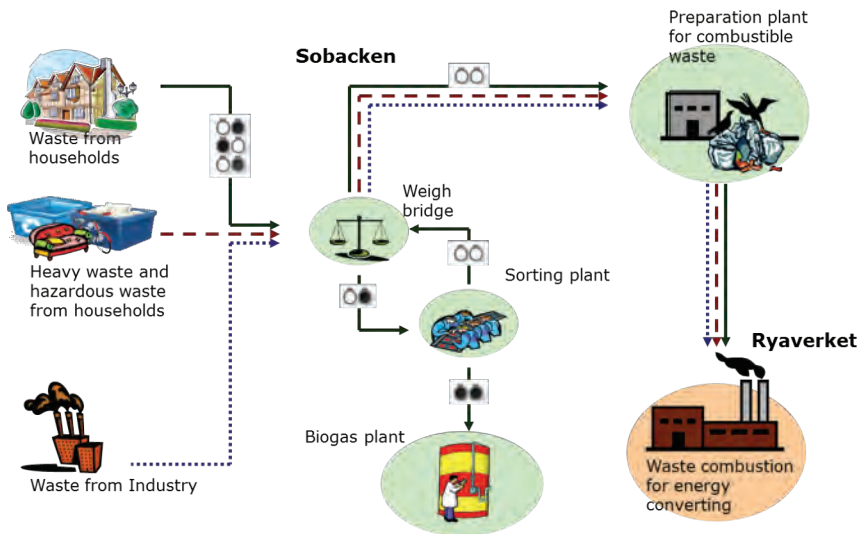

Figure 6. The recycle process for Borås, turning waste into biogas or heat. (Carlsson 2013)

water be handled in a sustainable society? As the largest polytechnical institute in Sweden, SP has more than 1,300 employees and 20,000 customers and partners, including major national and international companies and institutions, and small and medium enterprises in a range of different industries.

Of special interest to the readers of this publication is that SP is currently designing and evaluating small-scale biogas-run systems for wastewater treatment. These container-sized facilities could be used for rural communities in developing countries.

It soon became evident that Dr. Yarahmadi had extensive knowledge about matters relating to developing countries and their lack of potable water and similar issues. In fact, her appearance at the conference led to SP partnering with OTEC Africa and other conference members in submitting the grant application from Sida/USAid. Among other things, Mrs. Yarahmadi mentioned that on an average year, 3.4 million people die from the lack of clean water, an area where OTEC is unsurpassable.

Borås Energy and Environment and SP work closely together with the School of Engineering at the University of Borås and the City of Borås on waste management research. In fact, the cluster is a world leader in this

particular field and why a large UN conference was held just a few weeks before the OTEC Africa conference in the very same building, initiated by Dr. Hans Björk at the School of Engineering. The city gets many visitors each year studying its work on sustainability.

“Track 0”: OTEC organizations

Not a track of its own but rather talks about the current OTEC organizations included:

- ♦ Petter Dessne., OTEC Africa, Sweden: “Opening address: Setting the stage”
- ♦ Thomas Bjelkeman-Pettersson, Entrepreneur and Engineering Director at Akvo Foundation, Sweden, and Paul Dinnissen, OTEC Foundation, The Netherlands: “The prospects of OTEC; Bringing international development work online”

In my opening address, I aimed to focus the upcoming discussions on OTEC as a tool for enabling a sustainable development in developing countries. Some of my reflections are included in the introductory chapter of this volume.

Mr. Bjelkeman-Pettersson is the founder of OTEC Foundation and OTEC News. Mr. Paul Dinissen is now in charge of OTEC Foundation. As



Figure 7. Paul Dinnissen and Thomas Bjelkeman giving a joint presentation of their work for OTEC. Photo by the author.

hinted in the presentation title, they gave a rather relaxed talk on the history of OTEC Foundation and the future of OTEC from an entrepreneur perspective.

In addition, Mr. Bjelkeman-Pettersson spoke about his work at Akvo. Akvo is a project to transform the way development cooperation is organized across the world. The goal is to become the definitive, internet-based global transparency and collaborative platform for development aid. Headquartered in Amsterdam, Akvo is a non-profit foundation that works with more than a thousand organizations around the world.

Reflections on the conference

The event was the world's first international conference dedicated to OTEC technology and sustainability. Thanks to everyone's participation, it is now hopefully a bit easier to build an environmentally sound future for the developing countries around the globe, and to prove OTEC to be a safe and financially suitable technology for electrical power and potable water.

The speeches represented the many facets of OTEC, sustainability, and developing countries. To me, it's more clear than ever that the link between these three entities is, or can be, very strong. OTEC is without a doubt a



Figure 8. About a third of the attendees of the conference, including thirteen of the speakers. Photo by Susann Evertsson.

great technology in itself, but it also has merits for creating a sustainable future for developing countries in Africa and Asia.

Apart from getting to know one another, we all learnt a lot from the conference. A few things I would like to share:

1. While it's true that OTEC is more economically feasible the larger the plants are, under the right circumstances they don't have to be bigger than about 2-5 MW to be commercially sound.
2. Fresh water is often more expensive than electricity. Consequently, fresh water production from OTEC shouldn't be overlooked at this point. As Dr. Yarahmadi put it in her speech: Fresh water is inexpensive in rich countries and expensive in poor countries.
3. Judging from the number of photos taken on Linus Hammar's slides on possible OTEC sites outside East Africa, there is indeed a big interest in combining OTEC as clean energy and tool for aid.
4. The University of Borås has a high degree of acclaimed sustainability research, mainly related to sustainable cities and waste management, as shown above. OTEC research fits well here, bringing electrical power and fresh water to the infrastructure grid. OTEC research also fits nicely in the research areas of the various institutions the university works with, such as SP, the City of Borås, the coast-based Chalmers University, University of Gothenburg, the new center on graphene research, and the most recent partner, the University of the Highlands and Islands in Scotland (which performs a lot of maritime and environmental research). In addition, the university's unique Smart Textiles department, which combines textile and technical research, could be a potential partner for the OTEC industry. For example, strong textile fibers could be used for manufacturing temporary fresh water pipelines in areas suddenly hit by draught, or for creating flexible joints between OTEC platforms and the deep water pipes. Built in electronics could monitor the water flow and quality of the (fresh) water, check for leakage etc.
5. It is clear that the Scandinavian countries can do a lot for OTEC and development through the work of Sida and similar institutions. That said, OTEC can also be of value for small and big companies in the Scandinavian industry, such as the Swedish international corporations ABB, Sandvik, Alfa-Laval, SKF, Skanska, and SWECO, some of which are based in Western Sweden. The same

goes for the Norwegian and Danish industries, often geared towards offshore technology or cleantech.

6. One thing that was news to many of us, is that research is ongoing on heat exchangers made with a mixture of metal and graphene. Graphene is super strong, cheap, and non-corrosive, and would make the OTEC machinery last much, much longer. And so, using long-lasting components for OTEC, there is now a technology that offers clean energy and fresh water production as a "true" perpetuum mobile, using energy from the sun and clean water from million-year-old glaciers, carried and stored by the oceans.
7. I would also like to stress that we proved that it is possible to run a conference on OTEC; the technology is mature enough to not only result in sub-parts of another conferences. As Frederic Chino of DCNS said (and proved this summer): "OTEC is now!".

As should be apparent from reading this text, the conference envisioned a great future for OTEC, and at the same time, it was wonderful meeting everyone. In fact, many of the attendees – though well-known names in the trade – met each other for the first time. The weather was good, the excursion to the Textile Fashion Center was interesting, and we were served a much appreciated buffet dinner. We also had very good media coverage: two articles in Borås Newspaper, a feature in the New Technology magazine, one article at ungenergi.no and one at otecfoundation.org. Several of us were also interviewed by Swedish radio channel 4 or Swedish television channel 4.

To sum up, the OTEC Africa Conference 2013 attracted twenty speakers from eleven countries – Sweden, Norway, United Kingdom, France, The Netherlands, Italy, Kenya, Iran, USA, South Korea, and Japan – and was held 132 years after OTEC was invented; indeed a long time from invention to the first international conference dedicated to the subject.

Concluding remarks

To conclude, OTEC is not anymore much about challenges but rather about opportunities. We can think of no competing cleantech technology that can bring potable water and electricity to close to three billion people in developing countries, and a high oil price and a global awareness of the need

to go green has suddenly made OTEC one of the most promising clean technologies.

One thing that is unique for the OTEC community is the friendly spirit – there is no real sense of competition between industry people or scientists but rather so many possible roads to take that all parties come together. This tightly knit community of practice makes OTEC research and realization even stronger, and gives room to OTEC plant production in certain developing countries. Through the concerted effort by all of us, scientists and industry people alike, we can accelerate this development as Africa and many other warm regions around the Globe have immediate needs for clean water and sustainable clean energy.

Indeed, the future of OTEC looks bright, but there is still a lot of work to be done. There are many ways to further improve the technology, and because of its unsurpassed versatility, the next few years will probably see some experimenting on combining OTEC for electrical power, potable water, cooling buildings, strengthening the fishery sector, and more. So, for the OTEC community as a whole, we are now approaching a very interesting time.

Of course, OTEC Africa is looking ahead as well. The set goals of the organization for the coming few years are:

- ♦ Investigating the possibility of putting together an OTEC session at World Water Week 2015 (which will have sustainability and developing countries as its annual theme)
- ♦ Applying for grants to enable travelling and more exposure
- ♦ Applying for grants to enable collaborative research combining Scandinavian and worldwide parties
- ♦ Producing one or two more volumes of *OTEC Matters*
- ♦ Continue to channel its ideas via media, and to educate politicians, researchers, industry people, and the general public of OTEC's benefits
- ♦ Continue to connect scientists and industry people from all over the world.

There are two major that will decide whether the organization and the OTEC community will be successful or not. One is getting the necessary funding for further installing and developing OTEC technology and the

other is the ability to convince leading government officials and engineers of the benefits of OTEC.

As the OTEC Africa Conference 2013 and, later, the USAid/Sida application clearly showed, successful OTEC implementation needs people coming together from different disciplines. In a paper appropriately named “Revisiting OTEC”, the authors state that “successful implementation of OTEC at scale will require the application of insights and analytical methods from economics, technology, materials engineering, marine ecology, and other disciplines as well as a subsidized demonstration plant to provide operational data at near-commercial scales” (Fujita, Markham, Diaz Diaz, Martinez Garcia, Scarborough, Greenfield, Black & Aguilera 2012).

In addition to multi-disciplinary research, the future of OTEC depends on how well a bond between scientists, industry people, aid institutions, and governmental people can be formed. It is my hope that through the various activities of OTEC Africa in the past and in the future, this bond becomes strengthened, and so, the future may look brighter for OTEC, for mankind, and for planet Earth.

Petter Dessne works at the University of Borås, Sweden. He is the founder of OTEC Africa, organizer of the OTEC Africa Conference 2013, and editor of *OTEC Matters*.

References (including referred presentations)

- Aderibigbe, D. A. & Awosika, L. F. (2013). Opportunities for a Viable Commercial OTEC Technology in Nigeria. *OTEC Africa Conference 2013*, Borås, Sweden.
- Andréasson, A. (2011). Första biogasanläggningen enligt Boråsmodell invigd i Indonesien. *Borås energi och miljö*.
<http://www.borasem.se/nyheter/forstabiogasanlaggningenenligtborasmodellinvigdiindonesien.5.5315093d12da7c7ef17800026969.html> [2014-08-29]
- Carlsson, P. (2013). Borås Energy and Environment. *OTEC Africa Conference 2013*, Borås, Sweden.
- Fujita, R., Markham, A. C., Diaz Diaz, J. E., Martinez Garcia, J. R., Scarborough, C., Greenfield, P., Black, P. & Aguilera, S. E. (2012). Revisiting ocean thermal energy conversion. *Marine Policy*, 36(2), pp. 463-465.
- Hogan, Timothy. (2013). OTEC Warm Water Intake Design and Potential Environmental Impacts. *OTEC Africa Conference 2013*, Borås, Sweden.
- Hyeon-Ju, K. (2013). What is OTEC? The expansion of objectives. *OTEC Africa Conference 2013*, Borås, Sweden.
- Ikegami, Y. & Mutair, S. (2013). The Future of OTEC: A new step towards commercialization from Okinawa, Japan *OTEC Africa Conference 2013*, Borås, Sweden.
- Johnson, T. (2013). Keynote speech: OTEC in Africa and Commercializing/Financing OTEC. *OTEC Africa Conference 2013*, 2014-10-15 Borås, Sweden.
- Moore, J. & Rees, W. E. (2013). Getting to One-Planet Living. *Is Sustainability Still Possible?* Washington, D.C.: The Worldwatch Institute, pp. 39-50.
- OECD (2013). Aid to developing countries rebounds in 2013 to reach an all-time high. *OECD.org*.
- Petersen, B. O. (2013). The Challenge to Meet the Zero Vision of Shipping. *OTEC Africa Conference 2013*, Borås, Sweden.
- Sang, J. (2013). Kenya: A Nation of Opportunities. *OTEC Africa Conference 2013*, Borås, Sweden.
- Widell, P.-A. (2013). [The Cleantech Strategy of the Swedish government]. *OTEC Africa Conference 2013*, Borås, Sweden.
- WWF (2014). *The Global Cleantech Innovation Index 2014. Nurturing tomorrow's transformative entrepreneurs*. San Francisco, USA.

Opt for OTEC for a sustainable world!

Petter Dessne, founder OTEC Africa, University of Borås, Sweden,

Lars Golmen, Director Runde Environmental Centre, Norway,

Ted Johnson, Executive Director, Ocean Thermal Energy Corporation, USA,

*Desikan Bharathan, Principal Engineer at National Renewable Energy
Laboratory, USA,*

✉ Harold Lever, CEO, Archimedes Solutions, The Netherlands

This text was written to start a debate on sustainability and development of low-income countries in the beginning of 2014, and was published in the newspaper Svenska Dagbladet on February 14. The opinion piece was initiated as reaction to the recent disaster in the Philippines. Republished with permission, and translated from Swedish by the editor.

Famine disasters and typhoons claim their victims, creating unimaginable suffering in the world year after year. Aid agencies are doing what they can to help, and it's a commendable work, but even better would be if these disasters would not occur at all.

Due to the greenhouse effect, there has been an increased interest in alternative energy technologies. One such technique is OTEC (ocean thermal energy conversion). OTEC works similar to geothermal heating, and can be used at seas with warm surface water, such as around Africa, China, India, Indonesia, the Philippines, Japan, the Arab States, Brazil, and the southern United States. The temperature difference between surface and deep seawater is used in a process where water evaporates and is run through turbines. Generators create electricity, and the vaporization provides large quantities of fresh water. The only waste product is deep ocean water pumped out a few hundred meters down not to disturb the sea water's chemical balance.

Energy from OTEC, like all alternative energy, is more expensive than crude oil – otherwise it would not be alternative. OTEC's good qualities

combined with a high oil price and an increased awareness of the human impact on nature, however, has now resulted in plants beginning to be built outside islands and archipelagos such as Hawaii and Martinique.

In October, the first international conference entirely devoted to the OTEC technology was held at the University of Borås, with speakers from fifteen countries and representatives from the EU and the Government of Sweden. The message was clear: OTEC is now commercially interesting and especially important for developing countries. Many developing countries have an economic growth rate of over five percent per year, providing a chance to a better life for many, but at the same time posing environmental challenges.

OTEC fits well into Scandinavia's approach of aid for development, as well as in the government's view on the export of environmental technology. There are thus significant export opportunities for both small companies and large companies in Sweden's energy sector. Norway is a leader in the offshore industry, and Denmark is a pioneer in alternative energy.

That electricity from OTEC can create a sustainable future for developing countries is clear. The large amounts of fresh water are also a huge asset: OTEC would in theory have been able to avert the famine disaster in the Horn of Africa at a lower cost than the charitable organization efforts. With a lifespan per site of about 25 years and weather independent production, OTEC would not only serve as a protection against famine, but also create a stable infrastructure for people in coastal countries. Each year three and a half million people die from contaminated drinking water. OTEC can save many of these people and improve the quality of life for millions of others.

The impacts of hurricanes (typhoons) have increased in recent years as the oceans warm up. Hurricanes are formed in very hot water, where OTEC fits best. By temporarily letting out the cold deep sea water at the surface when the hurricane risk is high, future OTEC plants placed in strategic locations can theoretically reduce the size of forming hurricanes, and so, disasters such as in the Philippines can possibly be reduced.

With increased research OTEC can continue to develop as a clean energy source with many good qualities. For example, graphene-coated heat exchangers can increase the lifespan many times over, resulting in less

expensive electrical power. The energy price can also be reduced by utilizing retired oil platforms as a base for OTEC plants. The Gulf of Mexico alone has 4,000 oil rigs today, and in the future, OTEC can, in addition to serving the region with electrical power and fresh water, possibly be able to protect New Orleans and other cities against hurricanes.

It is now that African countries build their infrastructure and this can be done in a sustainable way if we act quickly. We can also mitigate disasters and provide for a highly attractive Nordic export product. We therefore urge the Nordic governments, cleantech companies, researchers, donor agencies, aid organizations, and environmental organizations to participate in the work for a sustainable future with clean offshore technology. The Nordic countries are international leaders in both cleantech and aid work and together we can create better conditions for both the Nordic industry and for a sustainable world.

For mankind as a whole, and in many respects, the world is becoming a better place each year. In both rich and poor countries the standard of living has improved steadily for a very long time. This progress has a serious drawback, the negative effects on Earth's climate. It is clear that the only way we can live sustainably is by consuming much less. However, this is not enough: there is an undeniable need for new energy sources.

As the world's population grows, many countries will also face more severe shortages of food and of fresh, disease-free water. Most developing countries are situated in tropical regions and are therefore hit hard by increasing tropical storms and similar weather-based disasters, adding to these problems.

Ocean Thermal Energy Conversion (OTEC) technology has been proven to be an ideal candidate for addressing and resolving all of these problems for small island developing states (SIDS), and a few months ago, the EU set aside €2 million euros for constructing OTEC plants outside Martinique. Built on a much larger scale, OTEC can, as the only technology known to man, supply the world with its total energy and fresh water needs, increase seafood production many times over, and cooling off parts of the sea surface when they become too hot – all this without any atmospheric emissions.

Thus, it is with great excitement that this very first issue of the only journal dedicated to OTEC is being published. The publication covers many facets of OTEC and related matters, such as OTEC technology, sustainability including gender and other social studies, renewable energy, marine biology, metallurgy, and research on developing countries. The publication is aimed at two different audiences, scientists directly or indirectly involved with OTEC technology, and a more diverse group of people consisting of scientists from non-technical fields, industry people, politicians, investors, educators, and more. This volume is published as part of the publication series of the University of Borås, a progressive Swedish university with a high interest in and knowledge about sustainability.



UNIVERSITY
OF BORÅS